



swiss bed concept



Schlafwohl

Markenmatratzen & Bettsysteme



WOOD LINE

MASSIVHOLZ | BOIS MASSIF | SOLID WOOD

Achten Sie auf FSC®-zertifizierte Produkte | Soyez attentifs aux produits certifiés FSC® | Look for FSC®-certified products



Hasena – mein Bett

Hasena – mon lit | Hasena – my bed

Beständige Passion

Une passion constante
Enduring Passion



Mehr als ein Lebenswerk

Als Familienunternehmen gegründet, überzeugen wir seit über 70 Jahren mit hoher Qualität und Vielseitigkeit im Bereich Schlafzimmermöbel.

Plus que l'œuvre d'une vie

Fondée en tant qu'entreprise familiale, nous convainquons depuis plus de 70 ans par notre qualité élevée et notre polyvalence dans le domaine des meubles de chambre à coucher.

More than a life's work

Founded as a family business, we have been impressing with high quality and versatility in the field of bedroom furniture for over 70 years.

swiss bed concept



swiss bed concept

Ein cleveres Baukastensystem

Sie wählen Ihren favorisierten Bettrahmen aus und kombinieren dazu Füße und Kopfteil Ihrer Wahl. Dabei können Sie quer durch die Kollektionen auf unterschiedliche Materialien und Farben zugreifen.

Un système modulaire astucieux

Vous choisissez votre cadre de lit préféré et le combinez avec les pieds et les têtes de lit de votre choix. Vous pouvez choisir parmi une variété de matériaux et de couleurs dans toutes les collections.

A clever modular system

You choose your favourite bed frame and combine it with the feet and headboards of your choice. You can choose from a variety of materials and colours throughout the collections.

5 Jahre Garantie

Service de livraison rapide
5 years warranty



Unser Versprechen

Vom Baum zum Bett – mittels handwerklicher Perfektion und hochwertigen Materialien. Sie erhalten 5 Jahre Garantie auf die Material- und Oberflächenbeschaffenheit, sowie die fachgerechte Verarbeitung aller Modelle ab Kaufdatum. Weitere Informationen finden Sie auf unserer Website.

Notre promesse

De l'arbre au lit – grâce à un artisanat parfait et des matériaux de haute qualité. Vous bénéficiez d'une garantie de 5 ans sur la qualité des matériaux et des surfaces, ainsi que sur la fabrication professionnelle de tous les modèles à compter de la date d'achat. Vous trouverez plus d'informations sur notre site Internet.

Our promise

From tree to bed – by means of perfect craftsmanship and high-quality materials. You receive a 5-year guarantee on the material and surface quality, as well as the professional workmanship of all models from the date of purchase. Further information can be found on our website.

Schnellieferservice

Service de livraison rapide
Quick delivery service



Komfort ohne Wartezeit

Mit unserem Schnellieferservice «PRONTO» können wir eine grosse Auswahl an Betten mit Beimöbeln und alle Modelle aus Edition pronto, Dream pronto und Boxspring pronto ab Lager liefern.

Le confort sans attente

Notre service de livraison rapide « PRONTO » permet de livrer un large choix de lits, de meubles d'appoint et tous les modèles de l'Édition Pronto, Dream pronto et Boxspring Pronto à partir du stock.

Comfort without waiting

With our quick delivery service «PRONTO» we can offer a large selection of beds with ancillary furniture and all models from models from Edition pronto, Dream pronto and Boxspring pronto from stock.





Vielseitig kombinierbar

Unser ausgeklügeltes Baukastensystem «swiss bed concept» bietet eine riesige Auswahl an Füßen, Kopfteilen und Beimöbeln. Darüber hinaus umfasst es verschiedene Stoff-, Kunstleder- und Lederbezüge sowie diverse Holz- und Metallausführungen. Abgestimmte Lattenroste und Matratzen komplettieren unsere Betten zur Wohlfühlloase.

Combinable à versatile

Notre système modulaire sophistiqué «swiss bed concept» propose un choix énorme de pieds, têtes de lits et accessoires. Par ailleurs le comporte différents tissus, cuirs synthétiques et véritables, ainsi que diverses variantes de bois et métal. Des sommiers à lattes et des matelas adaptés complètent nos lits pour un espace bien-être.

Versatile combinable

Our ingenious modular system «swiss bed concept» offers a huge selection of feet, headboards and accessories. In addition, it includes different fabrics, synthetic leather and real leather covers and different wood and metal versions. Matching slatted frames and mattresses complete our beds to an oasis of well-being.

Nachhaltigkeit bei Hasena

Unser wichtigster Lieferant, die Natur, ist sensibel und benötigt lange Regenerationszeiten bei Überbeanspruchung. Wir respektieren die von uns genutzten Ökosysteme und stellen unsere Produkte nachhaltig und mit hohem sozialen Engagement her.



Soziale Verantwortung

Responsabilité sociale
Social responsibility



Holzoberflächen

Surfaces en bois
Wood surfaces



Stabil im Aufbau

Unsere Betten überzeugen durch eine hohe Stabilität. Mittels Einsatz verschiedener Traversen ist eine gesamthafte Belastung von 300 bis 450 kg, inklusive Lattenroste und Matratzen, möglich.

Construction robuste

Nos lits sont convainçants par leur grande stabilité. En utilisant différentes fermes, une charge totale de 300 à 450 kg, y compris les sommiers à lattes et les matelas, est possible.

Solid in construction

Our beds convince with their high stability. By using different trusses, a total load of 300 to 450 kg, including slatted frames and mattresses, is possible.

Durabilité chez Hasena

Notre fournisseur le plus important, la nature, est sensible et nécessite un long temps de régénération en cas de surutilisation. Nous respectons les écosystèmes que nous utilisons et fabriquons nos produits de manière durable et avec un haut niveau d'engagement social.



Holzbeschaffung

Approvisionnement en bois
Wood procurement



Recycelte Stoffe

Tissus recyclés
Recycled fabrics



Einfach in der Montage

Unser Betten-System begeistert durch einen einfachen Aufbau mit leicht verständlicher Montageanleitung sowie hochwertigen Verbindungselementen, welche einen vielfachen Ab- und Wiederaufbau ermöglichen.

Montage facile

Notre système de lits séduit par une installation facile grâce aux instructions de montage bien compréhensibles ainsi que par les éléments de fixation haut de gamme permettant de monter et démonter les lits à de nombreuses reprises.

Solid in construction

Our beds convince with their high stability. By using different trusses, a total load of 300 to 450 kg, including slatted frames and mattresses, is possible.

Sustainability at Hasena

Our most important supplier, nature, is sensitive and needs long regeneration times in case of overuse. We respect the ecosystems we use and manufacture our products sustainably and with a high level of social commitment.



Produktion Massivholz

Production bois massif
Manufacturing solid wood



Energiegewinnung

Production énergétique
Production of energy



Bettrahmen | Cadre de lit | Bedframe



Classic 16



Breiten | Largeurs | Widths:
90, 100, 120, 140, 160, 180, 200 cm

Längen | Longueurs | Lengths: 190, 200, 210, 220 cm

Einlegetiefe | Hauteur encastrable | Insertion depth:
16 cm

Der Classic 16 Rahmen ist nicht in Eiche bright und Eiche brandy erhältlich.

Le cadre Classic 16 n'est pas disponible en chêne bright et en chêne brandy.

The Classic 16 frame is not available in oak bright and oak brandy.

Premium 18



Breiten | Largeurs | Widths:
90, 100, 120, 140, 160, 180, 200 cm

Längen | Longueurs | Lengths:
200, 210, 220 cm

Einlegetiefe | Hauteur encastrable | Insertion depth:
18 cm

Premium 23



Breiten | Largeurs | Widths:
140, 160, 180, 200 cm

Längen | Longueurs | Lengths:
200, 210, 220 cm

Einlegetiefe | Hauteur encastrable | Insertion depth:
18*, 23 cm

Ausführungen | Exécutions | Executions

Holz | Bois | Wood



06
Buche natur, lackiert
Hêtre naturel, laqué
Natural beech, lacquered



07
Buche schoko, lackiert
Hêtre teinté chocolat, laqué
Beech chocolate coloured, lacquered

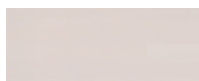

09
Buche weiss lasiert, lackiert
Hêtre teinté blanc lasuré, laqué
Beech white stained, lacquered



74
Eiche bright, geölt
Chêne bright, huilé
Oak bright, oiled



76
Eiche brandy, geölt
Chêne brandy, huilé
Oak brandy, oiled



80
Kernbuche natur, geölt
Hêtre cœur rouge naturel, huilé
Heart beech natural, oiled

Traversen | Traverses | Bars

Wir empfehlen grundsätzlich den Einsatz von Crosstraver (Quertraverse) oder Midtraver (Längstraverse).

Nous recommandons en général l'utilisation de Crosstraver (traverse transversale) ou Midtraver (traverse centrale).

We recommend basically the insertion of Crosstraver (central cross bar) or Midtraver (central bar).

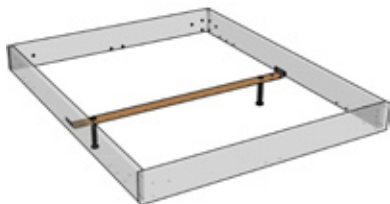

Crosstraver

Quertraverse | Traverse transversale | Central cross bar

Für alle Bettbreiten | Pour toutes les largeurs de lit | For all bed widths

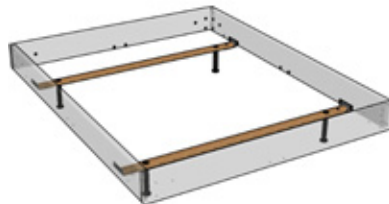

Crosstraver-Twin

Quertraversen | Traverses transversales | Cross bars

Für alle Bettbreiten | Pour toutes les largeurs de lit | For all bed widths

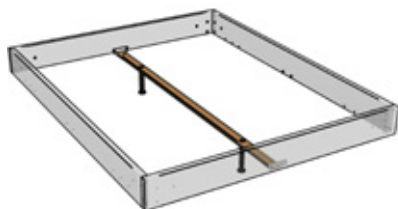

Midtraver

Längstraverse | Traverse centrale | Central bar

Für Betten ab Breite 140 cm mit 2 Lattenrosten oder Motorrahmen-einbau | Pour les lits à partir de 140 cm de largeur avec 2 sommiers ou l'installation d'un cadre motorisé | For beds from 140 cm width with 2 slats or motor frame installation

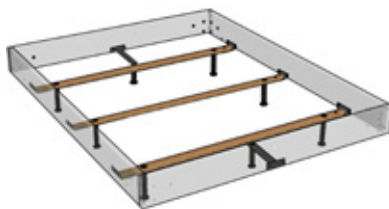

Crosstraver-XXL

Quertraversen | Traverses transversales | Cross bars

Für alle Bettbreiten | Pour toutes les largeurs de lit | For all bed widths

Übersicht Kompatibilität Traversen siehe Gesamtkatalog Seite 2.12 | Aperçu compatibilité traverses voir catalogue général page 2.12 | Overview compatibility bars see general catalogue page 2.12

* Premium 23

Bei der Einlegetiefe 18 cm sind die Füße/Sockel um 5 cm versenkt und um diese Höhe weniger sichtbar.

Avec les équerres en position haute (18 cm) les pieds/socle sont encastrés de 5 cm sous le cadre et donc moins visibles.

With the insertion depth 18 cm the feet/socket are sunken in by 5 cm and this height less visible.

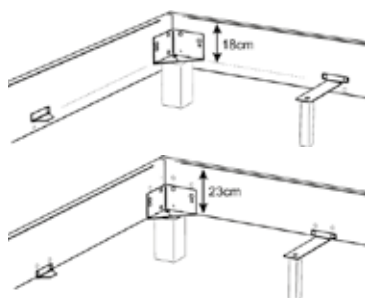

Option Midtraver-move

Achtung: nicht bei Füßen in der Höhe 30 cm, Lovie-Box und Practico-Box einsetzbar

Attention : ne s'applique pas aux pieds à une hauteur de 30 cm, Lovie-Box et Practico-Box

Attention: not applicable for feet at a height of 30 cm, Lovie-Box and Practico-Box

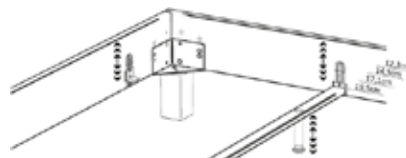

Modern, einzigartig, wertbeständig

Unsere Wood-Line ist ebenso langlebig wie das Holz, aus dem es gemacht ist und bietet Schlafkomfort auf hohem Niveau: modern, zeitlos und wertbeständig. Natürlich gewachsene Unregelmäßigkeiten in Farbe, Maserung und Oberfläche schenken dem massiven Holz und den Möbeln dieser Linie einen sehr natürlichen und einzigartigen Charakter.

Moderne, unique, de valeur stable

Le concept Wood-Line est aussi durable que le bois dont il est fait et offre un grand confort de sommeil : moderne, intemporel et durable. Les irrégularités naturelles de couleur, de grain et de surface donnent au bois massif et aux meubles de cette ligne un caractère très naturel et unique.

Modern, unique, stable in value

The Wood-Line concept is just as durable as the wood it is made of and offers a high level of sleeping comfort: modern, timeless and of lasting value. Naturally grown irregularities in colour, grain and surface give the solid wood and furniture of this line a very natural and unique character.

Füsse | Pieds | Feet

Holz | Bois | Wood



Amigo



Lana



Cantu



Ivio



Juve



Masi



Massa



Evio



Practico-Box



Vilo



Lovie-Box

90–140 (1 Schublade/Tiroir/Drawer)



Lovie-Box

140–200 (2 Schubladen/Tiroirs/Drawers)



Standard: gedämpfter Selbststeizug
Blumotion von BLUM

Option: Tip-On-Öffnung mit Vollauszug von BLUM

Standard: système d'amortissement
Blumotion de BLUM

Option: ouverture Tip-On avec sortie totale de BLUM

Standard: soft closing runner Blumotion of BLUM

Option: opening Tip-On with full extension of BLUM

Holz | Bois | Wood

	Masse cm Dim. cm	Breiten cm Largeurs cm Widths cm	Höhen cm Hauteurs cm Heights cm				Holzfarben Couleurs bois Colours wood												
			10	20	25	30	06	07	09	10	16	74	76	80					
Amigo*	10×10																		
Lana																			
Cantu	8×8																		
Evio		90–200																	
Ivio	10×10																		
Juve	8×8																		
Masi	6×5,5																		
Lovie-Box** (1 Schublade/Tiroir/Drawer)		90–140																	
Lovie-Box** (2 Schubladen/Tiroirs/Drawers)		140–200																	
Massa**	16×16																		
Practico-Box (inkl. Boden fond inclus bottom included)		90–200																	
Vilo		90–200																	

Practico-Box aus MDF ummantelt. Holzfüsse sind aus Massivholz | Practico-Box en mdf laminé. Pieds en bois massif | Practico-Box in mdf coated. Wooden feet are of solid wood.
* nur mit Classic 16 Rahmen möglich | uniquement possible avec cadre Classic 16 | only possible with frame Classic 16

**bei Premium 23 nur Einlegetiefe 23 cm möglich | pour Premium 23 uniquement possible avec hauteur encastrable de 23 cm | for Premium 23 only possible with insertion depth of 23 cm



06
Buche natur, lackiert
Hêtre naturel, laqué
Natural beech, lacquered



07
Buche schoko, lackiert
Hêtre teinté chocolat, laqué
Beech chocolate coloured, lacquered

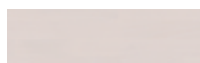

09
Buche weiss lasiert, lackiert
Hêtre teinté blanc lasuré, laqué
Beech white stained, lacquered

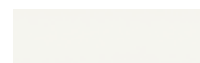

10
Buche weiss deckend, lackiert
Hêtre blanc couvrant, laqué
Beech white covered, lacquered



16
Buche anthracit deckend, lackiert
Hêtre anthracite couvrant, laqué
Beech anthracite covered, lacquered



74
Eiche bright, geölt
Chêne bright, huilé
Oak bright, oiled



76
Eiche brandy, geölt
Chêne brandy, huilé
Oak brandy, oiled



80
Kernbuche natur, geölt
Hêtre coeur rouge naturel, huilé
Heart beech natural, oiled

Füsse | Pieds | Feet

Metall | Métal | Metal

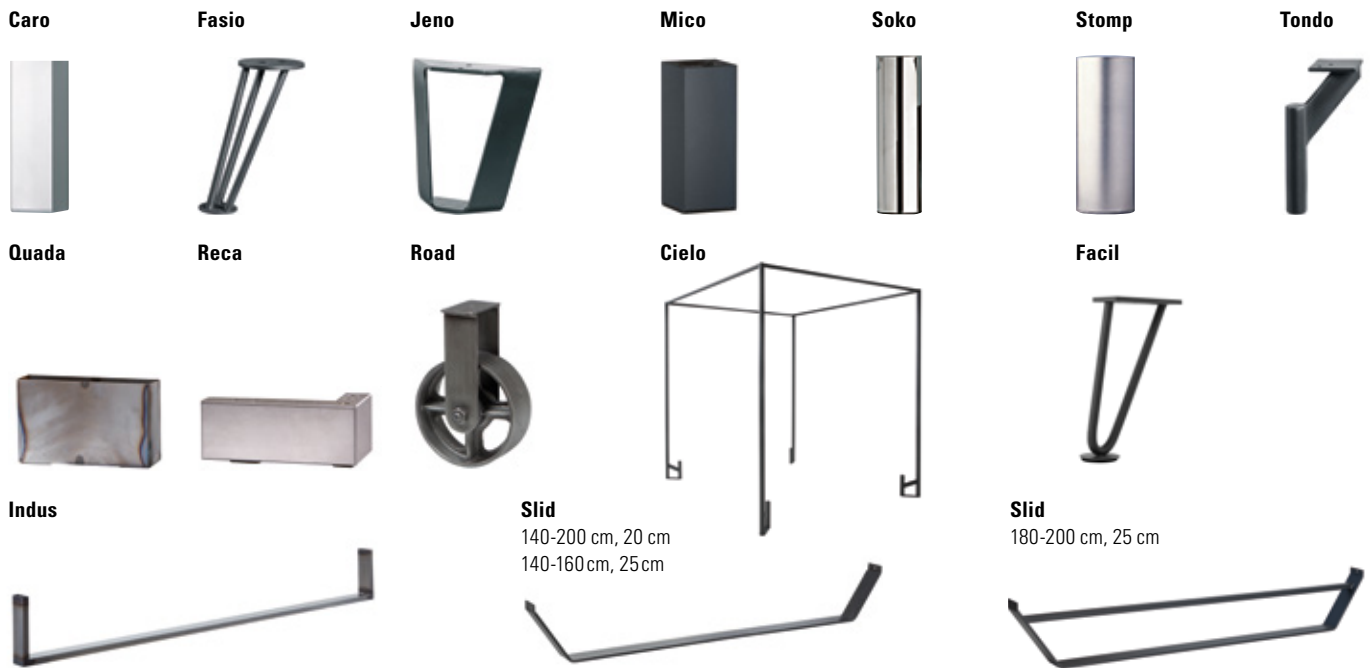

Metall | Métal | Metal

	Masse cm Dim. cm	Breiten cm Largeurs cm Widths cm	Höhen cm Hauteurs cm Heights cm				Metallfarben Couleurs métal Colours metal								
			10	20	25	30	00	04	10	16	40	41	42	43	45
Caro	6×6			●	●		●			●		●			●
Cielo [▲]		120–200		●					●						
Facil				●											
Fasio	∅ 5/9			●						●		●			
Indus	6×2	140–200		●	●					●					●
Jeno	12×5		●	●	●				●						
Mico	8×8		●	●	●	●		●				●	●	●	●
Quada	20×6,5			●	●										●
Reca	24×12		●											●	
Road*	∅ 13			●					●						
Slid	8/1	140–200		●	●					●				●	
Soko	∅ 6			●	●			●						●	
Stomp	∅ 8		●	●	●	●		●						●	
Tondo	∅ 3,5			●										●	

* Füsse fixiert, Rollen nur optisch | Pieds fixes, roulettes uniquement décoratives | Feet fixed, castors only visual

[▲] Curty Vorhang und Vela Baldachin-Tuch siehe Gesamtkatalog Register 2, Seite 12 | Curty rideau et Vela tissu de baldachin voir catalogue général registre 2, page 12 | Curty curtain and Vela canopy cloth see general catalogue index 2, page 12



00 Chrom = Edelstahl poliert | Acier poli | Stainless steel polished

04 Used = Stahl galvanisiert | Acier galvanisé | Steel galvanised

10 White = Stahl pulverbeschichtet | Acier thermolaqué | Steel powder-coated

16 Anthracit = Stahl pulverbeschichtet | Acier thermolaqué | Steel powder-coated

40 Bronze = Stahl lackiert | Acier laqué | Steel lacquered

41 Copper = Stahl lackiert | Acier laqué | Steel lacquered

42 Alu = Stahl pulverbeschichtet | Acier thermolaqué | Steel powder-coated

43 Inox = Edelstahl geschliffen | Acier poncé | Stainless steel ground

45 Iron = Stahl geflammt, pulverbeschichtet | Acier flammé, thermolaqué | Steel mottled, powder-coated

Kopfteile | Têtes de lit | Headboards



Dia



Dimension: 90/100, 120, 140, 160, 180/200

Duetto



Dimension: 90/100, 120, 140, 160, 180, 200

Lara

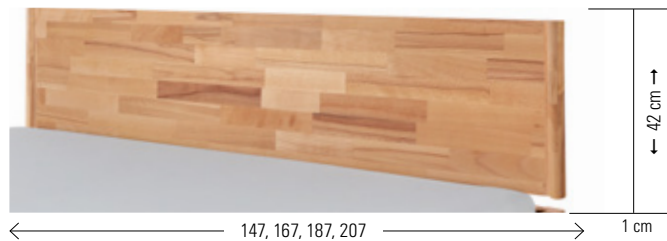

Dimension: 140, 160, 180, 200

Litto



Dimension: 140, 160, 180/200

Sandro



Dimension: 90/100, 120, 140, 160, 180, 200

Varus

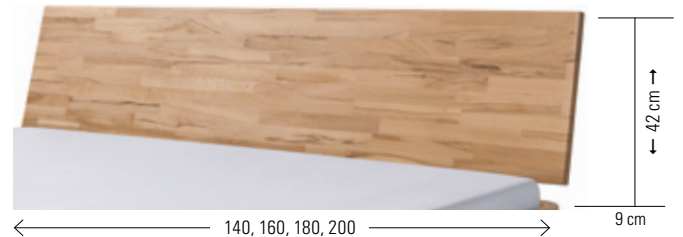

Dimension: 140, 160, 180, 200

Vola

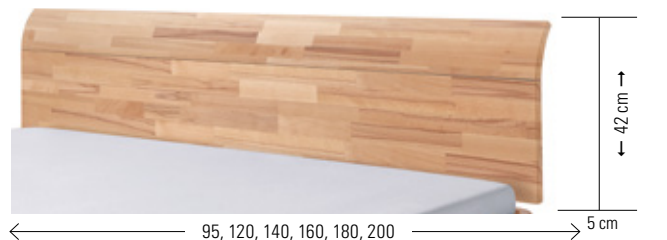

Dimension: 90/100, 120, 140, 160, 180, 200

Kopfteil | Têtes de lit | Headboard

Holzfarben

Couleurs bois
Colours wood

	06	07	09	74	76	80
Dia	●	●	●			●
Duetto	●	●	●	●	●	●
Litto	●	●	●			●
Lara	●	●	●	●	●	●
Sandro	●	●	●	●	●	●
Varus	●	●	●	●	●	●
Vola			●	●	●	●

Holz | Bois | Wood

 	 	 	 	 	 
<p>06 Buche natur, lackiert Hêtre naturel, laqué Natural beech, lacquered</p>	<p>07 Buche schoko, lackiert Hêtre teinté chocolat, laqué Beech chocolate coloured, lacquered</p>	<p>09 Buche weiss lasiert, lackiert Hêtre teinté blanc lasuré, laqué Beech white stained, lacquered</p>	<p>74 Eiche bright, geölt Chêne bright, huilé Oak bright, oiled</p>	<p>76 Eiche brandy, geölt Chêne brandy, huilé Oak brandy, oiled</p>	<p>80 Kernbuche natur, geölt Hêtre cœur rouge naturel, huilé Heart beech natural, oiled</p>

Kissen zu Kopfteilen | Coussins pour têtes de lit | Cushions for headboards

Arona + Duetto



Lumo + Duetto



Ravo + Varus



Suny + Litto



Befestigung mit 2 Bändern (Klettverschluss)

Fixation avec 2 bandes (Velcro®)

Fixation with 2 ribbons (Velcro®fastener)

Varo + Varus



Stoffauswahl/Farben für Kissen siehe Gesamtkatalog Register 1, Seiten 6–7

Choix de tissus/couleurs pour coussins voir catalogue général registre 1, pages 6–7

Choice of tissues/colours for cushions see general catalogue index 1, pages 6–7



Gepolsterte Kopfteile, Wandpaneele, Stoffauswahl/Farben siehe Gesamtkatalog Register 1, Leselampen siehe Gesamtkatalog Register 2.

Têtes de lits rembourrées, panneaux muraux, choix de tissus/couleurs voir catalogue général registre 1, lampes de lecture voir catalogue général registre 2.

Upholstered headboards, wallpanels, choice of tissues/colours see general catalogue index 1, reading lamps see general catalogue index 2.

Kissen | Coussins | Cushions

Effektive Masse cm

Dimensions effectives cm
Effective dimensions cm

Arona	86, 116, 136, 156, 176×3,5×25
Lumo	86, 116, 136, 156, 176×6×25
Suny (2er Set set de 2 set of 2)	55×6×40
Ravo	80, 110, 130, 150, 170, 190×3,5×35
Varo (2er Set set de 2 set of 2)	55×10×35

zu Kopfteilen

pour têtes de lit
for headboards

	Duetto	Dia	Lara	Litto	Varus
●	●				
●	●				
●	●	●	●	●	●
●	●	●	●	●	●
●	●		●	●	●

Breitenmasse cm

Dimensions de largeur cm
widths dimensions cm

90/100, 120, 140, 160, 180/200
90/100, 120, 140, 160, 180/200
90/100, 120, 140, 160, 180, 200

Adapter | Adaptateur | Adapter

Bei hohen Matratzen kann mit dem Verlängerungsadapter das Kopfteil um 9 oder 13 cm erhöht werden.

La tête de lit peut être rehaussée de 9 ou 13 cm avec l'adaptateur quand le matelas est plus épais.

With the extension adapter the headboard can be extended 9 or 13 cm if mattresses are high.

Alu für alle Holzfarben, ausser 74 und 76. Black für Holzfarben 74 und 76.

Alu pour toutes les couleurs de bois, sauf 74 et 76. Black pour les couleurs de bois 74 et 76.

Alu for all wood colours except 74 and 76. Black for wood colours 74 and 76.

Head-Plus Metall | Métal | Metal



alu

black

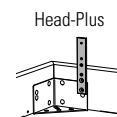
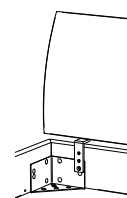

↑ +9 / +13 cm
↓

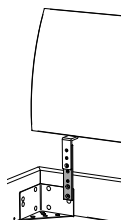

selezione

01

MODELLAUSWAHL

Sélection du modèle | Model selection

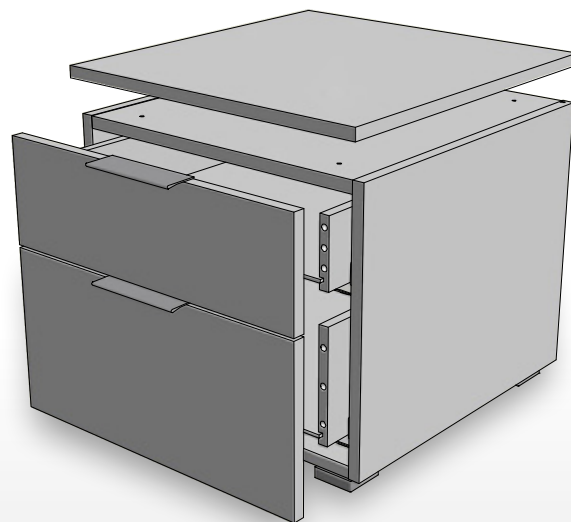

Twia



45/50/41 cm

Onia



45/50/41 cm

Owita



90/50/41 cm

Trio



45/50/55 cm

Dowe



45/50/55 cm

Dowio



90/50/55 cm

Quatro



45/50/86 cm

Unito



45/50/86 cm

Qunito



90/50/86 cm

Quatrine



90/50/86 cm

Portina



90/50/86 cm

Atrine



90/50/86 cm

Totrino



135/50/86 cm

Cassino



135/50/86 cm

Incentro



135/50/86 cm

Trequatri



135/50/86 cm

Stellen Sie sich Ihr Wunsch-Beimöbel nach Ihrem Geschmack zusammen: Der Korpus (Abb. 02), in zwei verschiedenen Farbvarianten, lässt sich zu den Front- und Top-Covern (Abb. 03) in acht Holz- und Farbausführungen kombinieren. Die Beimöbel können zerlegt oder teilmontiert bestellt werden. Bei zusammengesetzten Möbeln (z. B. Qunito, Incentro, ...) muss der Deckel noch montiert werden. Bei Kommoden mit Türen ist jeweils ein Einlegeboden vorhanden, Türöffnung nach links oder rechts möglich. Zusätzliche Böden sind erhältlich.

Composez le meuble d'appoint de vos rêves selon vos goûts : Le caisson (ill. 02), disponible en 2 variantes de couleurs, peut être combiné avec les façades et couvercles supérieurs (ill. 03) en 8 finitions de bois et de coloris. Les meubles d'appoint peuvent être commandés en kits ou assemblés. Pour les meubles assemblés (p. ex. Qunito, Incentro, ...) le couvercle doit encore être fixé. Les commodes avec portes sont équipées d'une étagère, ouverture de la porte possible à gauche ou à droite. Si besoin, des étagères supplémentaires sont disponibles.

Put together the side furniture you want according to your own taste: The body (fig. 02), in two different colour versions, can be combined with the front and top covers (fig. 03) in eight wood and colour versions. The furniture can be ordered disassembled or assembled. For assembled furniture (e.g. Qunito, Incentro, ...) the top cover must still be fitted. Chests of drawers with doors have one shelf, door opening possible to the left or right. Additional shelves are available.



Kombinationsbeispiele und techn. Informationen
Exemples et informations
Examples and informations

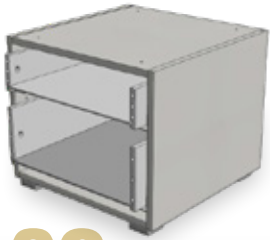

02

KORPUS

Caisson | Body



03

TOP/FRONT

Farben | Couleurs | Colours



04

GRIFFE

Poignées | Handles



10 Weiss | Blanc | White



16 Anthracit | Anthracite



FÜSSE

Pieds | Feet

STANDARD



OPTION

Leg 8 cm

Jone 10 cm

Cila 10 cm



alu



anthracit
used



anthracit



10 Weiss | Blanc | White



16 Anthracit | Anthracite

STANDARD



Alu

Griff zu Folienfronten

Poignée pour façades en mélaminé
Handle for foil fronts



74 Eiche bright, geölt
Chêne bright, huilé
Oak bright, oiled

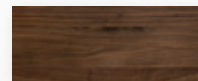

82 Nussbaum, geölt
Noyer, huilé
Walnut, oiled

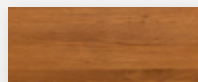

76 Eiche brandy, geölt
Chêne brandy, huilé
Oak brandy, oiled



87 Wildbuche natur, geölt
Hêtre nouveau naturel, huilé
Wildbeech natural, oiled



80 Kernbuche natur, geölt
Hêtre coeur rouge
naturel, huilé
Heart beech natural, oiled

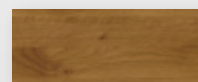

99 Wildeiche natur, geölt
Chêne nouveau naturel, huilé
Wildoak natural, oiled

STANDARD



Holzgriff zu Holzfronten

Poignée en bois pour façades en bois
Wooden handle for wooden fronts

OPTION

Rivo



Used



Anthracit

Metalgriff zu Holzfronten

Poignée en métal pour façades en bois
Metal handle for wooden fronts



The mark of
responsible forestry
FSC® C123546

Look for FSC® certified products



				Dimension cm
Lovara	Kommode	Commode	Chest of drawers	90/40/75
Dupla	Nachttisch	Table de nuit	Bedside table	48/40/35

Alle Holzteile in Kernbuche natur, geölt | Toutes les parties en bois en hêtre coeur rouge naturel, huilé | All wooden parts in heart beech natural, oiled
Weitere Beimöbel siehe Gesamtkatalog Register 2 | Autres accessoires voir catalogue général registre 2 | Further accessories see general catalogue index 2

Classic 16



	Dimension cm			
Classic 16	Rahmen Breiten Längen	Cadre Largeurs Longueurs	Frame Widths Lengths	90, 100, 120, 140, 160, 180, 200 190, 200, 210, 220
Masi	Füße Höhen	Pieds Hauteurs	Feet Heights	20, 25
Boga	Kopfteil, Campos blanc 372 siehe Gesamtkatalog Register 1	Tête de lit, Campos blanc 372 voir catalogue général registre 1	Headboard, Campos blanc 372 see general catalogue index 1	90, 100, 120, 140, 160, 180, 200

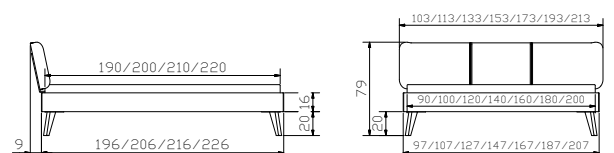



				Dimension cm
Varus	Kopfteil	Tête de lit	Headboard	140, 160, 180, 200
Duetto	Kopfteil	Tête de lit	Headboard	90/100, 120, 140, 160, 180, 200
Arona	Kissen, Kitana grigio 602	Coussin, Kitana grigio 602	Cushion, Kitana grigio 602	90/100, 120, 140, 160, 180/200

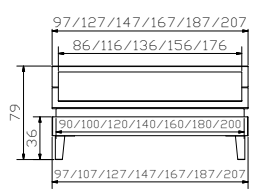
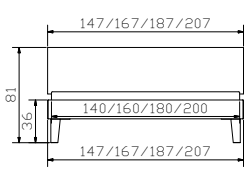



				Dimension cm
Classic 16	Rahmen Breiten Längen	Cadre Largeurs Longueurs	Frame Widths Lengths	90, 100, 120, 140, 160, 180, 200 190, 200, 210, 220
Juve	Füsse Höhen	Pieds Hauteurs	Feet Heights	20, 25
Dia	Kopfteil	Tête de lit	Headboard	90/100, 120, 140, 160, 180/200
Mido	Nachttisch	Table de nuit	Bedside table	40/35/10

Alle Holzteile in Kernbuche natur, geölt | Toutes les parties en bois en hêtre coeur rouge naturel, huilé | All wooden parts in heart beech natural, oiled

Weitere Beimöbel siehe Gesamtkatalog Register 2 | Autres accessoires voir catalogue général registre 2 | Further accessories see general catalogue index 2

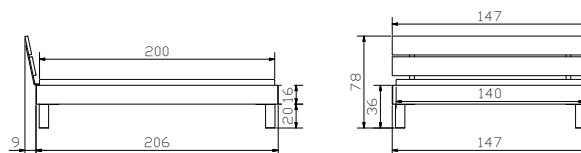



Lovie-Box

1 Bettkasten
Breiten
2 Bettkästen
Breiten
Höhe

1 Tiroir de lit
Largeurs
2 Tiroirs de lit
Largeurs
Hauteur

1 Bed drawer
Widths
2 Bed drawers
Widths
Height

Dimension cm

90, 100, 120, 140
140, 160, 180, 200
25

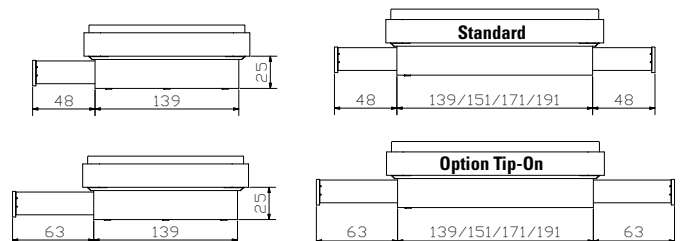



				Dimension cm
Classic 16	Rahmen Breiten Längen	Cadre Largeurs Longueurs	Frame Widths Lengths	140, 160, 180, 200 190, 200, 210, 220
Indus iron	Kufen Breiten Höhen	Patins Largeurs Hauteurs	Vats Widths Heights	140, 160, 180, 200 20, 25
Elipsa	Kopfteil, Casual cannelle 331 siehe Gesamtkatalog Register 1	Tête de lit, Casual cannelle 331 voir catalogue général registre 1	Headboard, Casual cannelle 331 see general catalogue index 1	140, 160, 180, 200
Caja	Nachtisch	Table de nuit	Bedside table	48/41/16
Aska	Sekretär	Secrétaire	Bureau	120/60/85

Alle Holzteile in Kernbuche natur, geölt | Toutes les parties en bois en hêtre coeur rouge naturel, huilé | All wooden parts in heart beech natural, oiled

Weitere Beimöbel siehe Gesamtkatalog Register 2 | Autres accessoires voir catalogue général registre 2 | Further accessories see general catalogue index 2

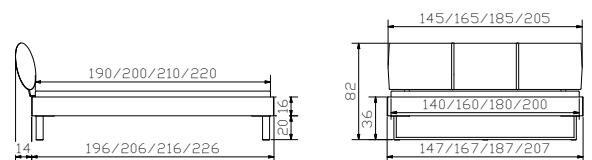



Dimension cm

	Kopfteil, Capo rose 762	Tête de lit, Capo rose 762	Headboard, Capo rose 762	90/100, 120, 140, 160, 180, 200
Ronna	Kopfteil	Tête de lit	Headboard	90/100, 120, 140, 160, 180, 200
Duetto	Kissen, Capo rose 762	Coussin, Capo rose 762	Cushion, Caop rose 762	90/100, 120, 140, 160, 180/200
Arona	Nachttisch	Table de nuit	Bedside table	48/41/16
Caja				

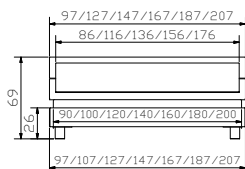
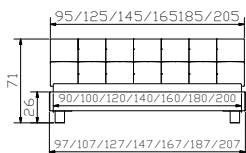



				Dimension cm
Classic 16	Rahmen Breiten Längen	Cadre Largeurs Longueurs	Frame Widths Lengths	90, 100, 120, 140, 160, 180, 200 190, 200, 210, 220
Cantu	Füsse Höhen	Pieds Hauteurs	Feet Heights	20, 25, 30
Duetto	Kopfteil	Tête de lit	Headboard	90/100, 120, 140, 160, 180, 200
Lumo	Kissen, Capo rose 762	Coussin, Capo rose 762	Cushion, Capo rose 762	90/100, 120, 140, 160, 180/200
Onia	Nachttisch	Table de nuit	Bedside table	45/49/40
Dowio	Kommode	Commode	Chest of drawers	90/49/55
Roll-Box 20 + Covero	Bettkasten Deckel Covero in weiss	Tiroir de lit Couvercle Covero en blanc	Bed drawer Covero in white	137/67/19

Alle Holzteile in Buche weiss lasiert, lackiert oder weiss | Toutes les parties en bois en hêtre teinté blanc lasuré, laqué ou blanc | All wooden parts in beech white stained, lacquered or white

Weitere Beimöbel siehe Gesamtkatalog Register 2 | Autres accessoires voir catalogue général registre 2 | Further accessories see general catalogue index 2

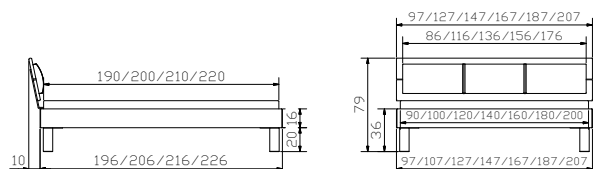



				Dimension cm
Dupla	Nachttisch	Table de nuit	Bedside table	48/40/35
Sola	Bank	Banquette	Bench	144/44/38
Claudio anthracit	Herrendiener	Valet	Dressboy	45/28/107

Alle Holzteile in Eiche brandy, geölt | Toutes les parties en bois en chêne brandy, huilé | All wooden parts in oak brandy, oiled

Weitere Beimöbel siehe Gesamtkatalog Register 2 | Autres accessoires voir catalogue général registre 2 | Further accessories see general catalogue index 2

Premium 18



				Dimension cm
Premium 18	Rahmen Breiten Längen	Cadre Largeurs Longueurs	Frame Widths Lengths	90, 100, 120, 140, 160, 180, 200 200, 210, 220
Slid anthracit	Füße Höhen	Pieds Hauteurs	Feet Heights	20, 25
Sandro	Kopfteil	Tête de lit	Headboard	90/100, 120, 140, 160, 180, 200

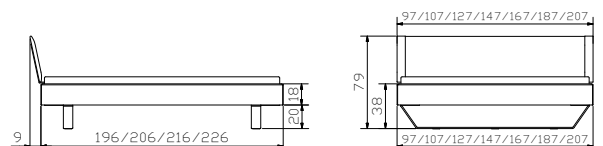



				Dimension cm
Dupla	Nachttisch	Table de nuit	Bedside table	48/40/35



Curty

Alle Holzteile in Buche weiss lasiert, lackiert

Toutes les parties en bois en hêtre teinté blanc lasuré, laqué
 All wooden parts in beech white stained, lacquered

Weitere Beimöbel siehe Gesamtkatalog Register 2

Autres accessoires voir catalogue général registre 2
 Further accessories see general catalogue index 2



				Dimension cm
Premium 18	Rahmen Breiten Längen	Cadre Largeurs Longueurs	Frame Widths Lengths	90, 100, 120, 140, 160, 180, 200 200, 210, 220
Cielo white	Baldachin Breiten Längen Höhe	Baldaqin Largeurs Longueurs Hauteur	Canopy Widths Lengths Height	120, 140, 160, 180, 200 200/210/220 20
Duetto	Kopfteil	Tête de lit	Headboard	90/100, 120, 140, 160, 180, 200

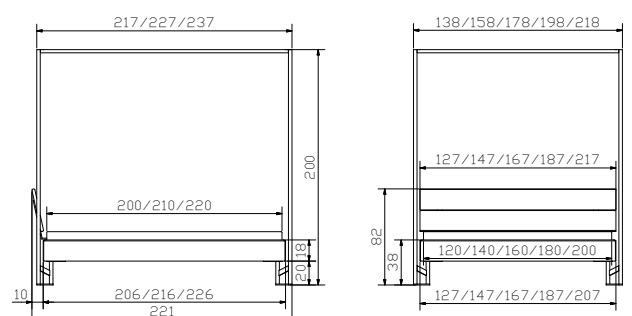
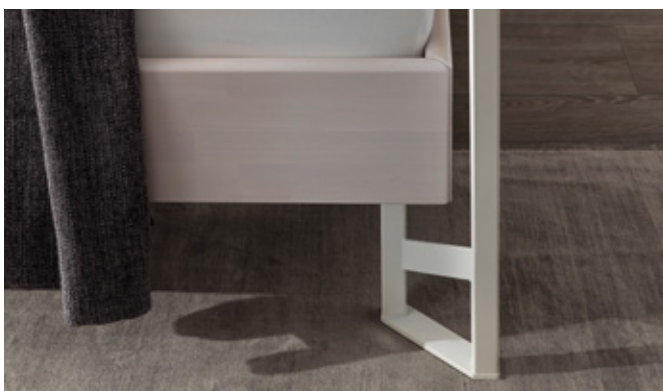



Twia	Nachttisch	Table de nuit	Bedside table	Dimension cm 45/49/40
-------------	------------	---------------	---------------	---------------------------------

Alle Holzteile in Kernbuche natur, geölt oder anthracit | Toutes les parties en bois en hêtre cœur rouge naturel, huilé ou anthracite | All wooden parts in heart beech natural, oiled or anthracite

Weitere Beimöbel siehe Gesamtkatalog Register 2 | Autres accessoires voir catalogue général registre 2 | Further accessories see general catalogue index 2



				Dimension cm
Premium 18	Rahmen Breiten Längen	Cadre Largeurs Longueurs	Frame Widths Lengths	90, 100, 12140, 160, 180, 200 200, (220)
Tondo anthracit	Füße Höhe	Pieds Hauteur	Feet Height	20
Ceneri	Kopfteil, Casual carbon 334 hat Einfluss auf Bettlänge siehe Gesamtkatalog Register 1 Seite 4	Tête de lit, Casual carbon 334 a un impact sur la longueur du lit voir catalogue général registre 1 page 4	Headboard, Casual carbon 334 affects the length of bed see general catalogue index 1 page 4	140, 160, 180, 200

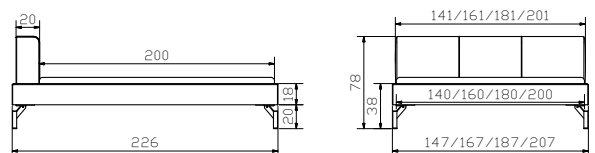



				Dimension cm
Styly	Nachttisch	Table de nuit	Bedside table	43/43/48
Sola	Bank	Secrétaire	Bureau	140/37/38

Alle Holzteile in Eiche bright, geölt | Toutes les parties en bois en chêne bright, huilé | All wooden parts in oak bright, oiled

Lampen und weitere Beimöbel siehe Gesamtkatalog Register 2 | Lampes et autres accessoires voir catalogue général registre 2 | Lamps and further accessories see general catalogue index 2

Premium 23



				Dimension cm
Premium 23	Rahmen Breiten Längen	Cadre Largeurs Longueurs	Frame Widths Lengths	140, 160, 180, 200 200, 210, 220
Lana	Füße Höhen	Pieds Hauteurs	Feet Heights	20, 25
Lara	Kopfteil	Tête de lit	Headboard	140, 160, 180, 200

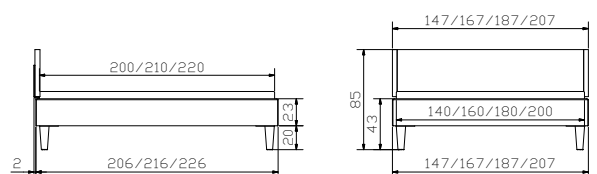



				Dimension cm
Aska	Sekretär	Secrétaire	Bureau	120/60/85
Claudio alu	Herrendiener	Valet	Dressboy	45/28/107
Treva	Nachttisch	Table de nuit	Bedside table	48/40/51

Alle Holzteile in Kernbuche natur, geölt | Toutes les parties en bois en hêtre coeur rouge naturel, huilé | All wooden parts in heart beech natural, oiled
Weitere Beimöbel siehe Gesamtkatalog Register 2 | Autres accessoires voir catalogue général registre 2 | Further accessories see general catalogue index 2



				Dimension cm
Premium 23	Rahmen Breiten Längen	Cadre Largeurs Longueurs	Frame Widths Lengths	120, 140, 160, 180, 200 200, 210, 220
Masi	Füße Höhen	Pieds Hauteurs	Feet Heights	20, 25
Cussina	Kopfteil, Ranch stone 660 siehe Gesamtkatalog Register 1	Tête de lit, Ranch stone 660 voir catalogue général registre 1	Headboard, Ranch stone 660 see general catalogue index 1	140, 160, 180, 200

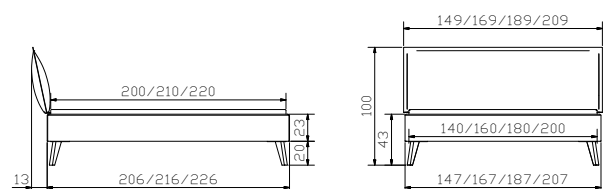

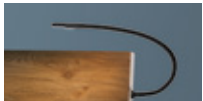

				Dimension cm
Lovara	Kommode	Commode	Chest of drawers	90/40/75
Treva	Nachttisch	Table de nuit	Bedside table	48/40/51
Boa chrom	Leselampe (2er Set) 12V DC, 12 LED warm	Lampe de lecture (set de 2) 12V DC, 12 LED warm	Reading lamp (set of 2) 12V DC, 12 LED warm	

Alle Holzteile in Eiche bright, geölt | Toutes les parties en bois en chêne bright, huilé | All wooden parts in oak bright, oiled

Leselampen und weitere Beimöbel siehe Gesamtkatalog Register 2 | Lampes de lecture et autres accessoires voir catalogue général registre 2 | Reading lamps and further accessories see general catalogue index 2



				Dimension cm
Premium 23	Rahmen Breiten Längen	Cadre Largeurs Longueurs	Frame Widths Lengths	140, 160, 180, 200 200, 210, 220
Cantu	Füße Höhen	Pieds Hauteurs	Feet Heights	20, 25, 30
Talma	Kopfteil, Cyclo creme 730 siehe Gesamtkatalog Register 1	Tête de lit, Cyclo creme 730 voir catalogue général registre 1	Headboard, Cyclo creme 730 see general catalogue index 1	140, 160, 180, 200

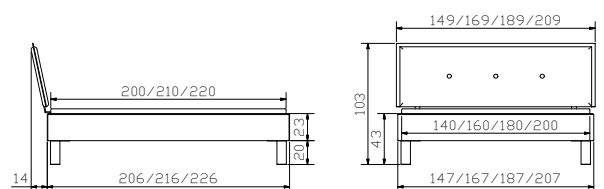



MOVIE-/TOP LINE



FACTORY LINE



WOOD LINE



LOUNGE



FINE LINE



NATURO LINE



OAK LINE



OAK WILD



DREAM LINE



**EDITION
BOXSPRING**



**FUNCTION/COMFORT
KIDS & GUESTS**



**LATTENROSTE &
MATRATZEN**



Gesamtkatalog
Catalogue général
General catalogue



Schlafwohl

Markenmatratzen & Bettsysteme