



swiss bed concept



*Schlafwohl*

Markenmatratzen & Bettsysteme



**NATURO LINE**

MASSIVHOLZ | BOIS MASSIF | SOLID WOOD

Achten Sie auf FSC®-zertifizierte Produkte | Soyez attentifs aux produits certifiés FSC® | Look for FSC®-certified products



# Hasena – mein Bett

Hasena – mon lit | Hasena – my bed

## Beständige Passion

Une passion constante  
Enduring Passion



### Mehr als ein Lebenswerk

Als Familienunternehmen gegründet, überzeugen wir seit über 70 Jahren mit hoher Qualität und Vielseitigkeit im Bereich Schlafzimmermöbel.

### Plus que l'œuvre d'une vie

Fondée en tant qu'entreprise familiale, nous convainquons depuis plus de 70 ans par notre qualité élevée et notre polyvalence dans le domaine des meubles de chambre à coucher.

### More than a life's work

Founded as a family business, we have been impressing with high quality and versatility in the field of bedroom furniture for over 70 years.

## swiss bed concept



swiss bed concept

### Ein cleveres Baukastensystem

Sie wählen Ihren favorisierten Bettrahmen aus und kombinieren dazu Füße und Kopfteil Ihrer Wahl. Dabei können Sie quer durch die Kollektionen auf unterschiedliche Materialien und Farben zugreifen.

### Un système modulaire astucieux

Vous choisissez votre cadre de lit préféré et le combinez avec les pieds et les têtes de lit de votre choix. Vous pouvez choisir parmi une variété de matériaux et de couleurs dans toutes les collections.

### A clever modular system

You choose your favourite bed frame and combine it with the feet and headboards of your choice. You can choose from a variety of materials and colours throughout the collections.

## 5 Jahre Garantie

Service de livraison rapide  
5 years warranty



### Unser Versprechen

Vom Baum zum Bett – mittels handwerklicher Perfektion und hochwertigen Materialien. Sie erhalten 5 Jahre Garantie auf die Material- und Oberflächenbeschaffenheit, sowie die fachgerechte Verarbeitung aller Modelle ab Kaufdatum. Weitere Informationen finden Sie auf unserer Website.

### Notre promesse

De l'arbre au lit – grâce à un artisanat parfait et des matériaux de haute qualité. Vous bénéficiez d'une garantie de 5 ans sur la qualité des matériaux et des surfaces, ainsi que sur la fabrication professionnelle de tous les modèles à compter de la date d'achat. Vous trouverez plus d'informations sur notre site Internet.

### Our promise

From tree to bed – by means of perfect craftsmanship and high-quality materials. You receive a 5-year guarantee on the material and surface quality, as well as the professional workmanship of all models from the date of purchase. Further information can be found on our website.

## Schnellieferservice

Service de livraison rapide  
Quick delivery service



### Komfort ohne Wartezeit

Mit unserem Schnellieferservice «PRONTO» können wir eine grosse Auswahl an Betten mit Beimöbeln und alle Modelle aus Edition pronto, Dream pronto und Boxspring pronto ab Lager liefern.

### Le confort sans attente

Notre service de livraison rapide « PRONTO » permet de livrer un large choix de lits, de meubles d'appoint et tous les modèles de l'Édition Pronto, Dream pronto et Boxspring Pronto à partir du stock.

### Comfort without waiting

With our quick delivery service «PRONTO» we can offer a large selection of beds with ancillary furniture and all models from models from Edition pronto, Dream pronto and Boxspring pronto from stock.







## Vielseitig kombinierbar

Unser ausgeklügeltes Baukastensystem «swiss bed concept» bietet eine riesige Auswahl an Füßen, Kopfteilen und Beimöbeln. Darüber hinaus umfasst es verschiedene Stoff-, Kunstleder- und Lederbezüge sowie diverse Holz- und Metallausführungen. Abgestimmte Lattenroste und Matratzen komplettieren unsere Betten zur Wohlfühloase.

## Combinable à versatile

Notre système modulaire sophistiqué «swiss bed concept» propose un choix énorme de pieds, têtes de lits et accessoires. Par ailleurs le comporte différents tissus, cuirs synthétiques et véritables, ainsi que diverses variantes de bois et métal. Des sommiers à lattes et des matelas adaptés complètent nos lits pour un espace bien-être.

## Versatile combinable

Our ingenious modular system «swiss bed concept» offers a huge selection of feet, headboards and accessories. In addition, it includes different fabrics, synthetic leather and real leather covers and different wood and metal versions. Matching slatted frames and mattresses complete our beds to an oasis of well-being.

## Nachhaltigkeit bei Hasena

Unser wichtigster Lieferant, die Natur, ist sensibel und benötigt lange Regenerationszeiten bei Überbeanspruchung. Wir respektieren die von uns genutzten Ökosysteme und stellen unsere Produkte nachhaltig und mit hohem sozialen Engagement her.



## Soziale Verantwortung

Responsabilité sociale  
Social responsibility



## Holzoberflächen

Surfaces en bois  
Wood surfaces



## Stabil im Aufbau

Unsere Betten überzeugen durch eine hohe Stabilität. Mittels Einsatz verschiedener Traversen ist eine gesamthafte Belastung von 300 bis 450 kg, inklusive Lattenroste und Matratzen, möglich.

## Construction robuste

Nos lits sont convainçants par leur grande stabilité. En utilisant différentes fermes, une charge totale de 300 à 450 kg, y compris les sommiers à lattes et les matelas, est possible.

## Solid in construction

Our beds convince with their high stability. By using different trusses, a total load of 300 to 450 kg, including slatted frames and mattresses, is possible.

## Durabilité chez Hasena

Notre fournisseur le plus important, la nature, est sensible et nécessite un long temps de régénération en cas de surutilisation. Nous respectons les écosystèmes que nous utilisons et fabriquons nos produits de manière durable et avec un haut niveau d'engagement social.



## Holzbeschaffung

Approvisionnement en bois  
Wood procurement



## Recycelte Stoffe

Tissus recyclés  
Recycled fabrics



## Einfach in der Montage

Unser Betten-System begeistert durch einen einfachen Aufbau mit leicht verständlicher Montageanleitung sowie hochwertigen Verbindungselementen, welche einen vielfachen Ab- und Wiederaufbau ermöglichen.

## Montage facile

Notre système de lits séduit par une installation facile grâce aux instructions de montage bien compréhensibles ainsi que par les éléments de fixation haut de gamme permettant de monter et démonter les lits à de nombreuses reprises.

## Solid in construction

Our beds convince with their high stability. By using different trusses, a total load of 300 to 450 kg, including slatted frames and mattresses, is possible.

## Sustainability at Hasena

Our most important supplier, nature, is sensitive and needs long regeneration times in case of overuse. We respect the ecosystems we use and manufacture our products sustainably and with a high level of social commitment.



## Produktion Massivholz

Production bois massif  
Manufacturing solid wood



## Energiegewinnung

Production énergétique  
Production of energy



# Bettrahmen | Cadre de lit | Bedframe



## Connecto 23



**Breiten** | Largeurs | Widths:  
140, 160, 180, 200 cm

**Längen** | Longueurs | Lengths:  
200, 210, 220 cm

**Einlegetiefe** | Hauteur encastrable | Insertion depth:  
18\*, 23 cm



## Ausführungen | Exécutions | Executions

### Holz | Bois | Wood



**87**  
**Wildbuche natur, geölt**  
Hêtre nouveau naturel, huilé  
Wildbeech natural, oiled

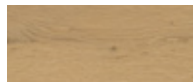

**96**  
**Wildeiche pure, gebürstet, geölt**  
Chêne nouveau pure, brossé, huilé  
Wildoak pure, brushed, oiled





# Traversen | Traverses | Bars



**Wir empfehlen grundsätzlich den Einsatz von Crosstraver (Quertraverse) oder Midtraver (Längstraverse).**

Nous recommandons en général l'utilisation de Crosstraver (traverse transversale) ou Midtraver (traverse centrale).

We recommend basically the insertion of Crosstraver (central cross bar) or Midtraver (central bar).

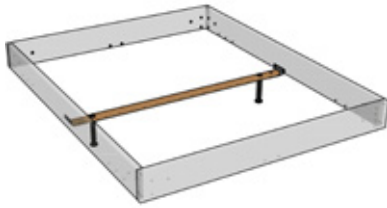

## Crosstraver

Quertraverse | Traverse transversale | Central cross bar

**Für alle Bettbreiten** | Pour toutes les largeurs de lit | For all bed widths

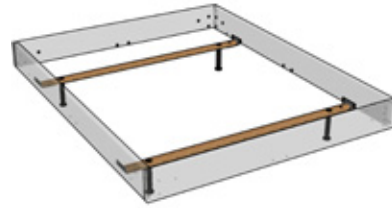

## Crosstraver-Twin

Quertraversen | Traverses transversales | Cross bars

**Für alle Bettbreiten** | Pour toutes les largeurs de lit | For all bed widths

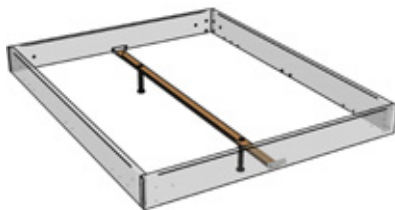

## Midtraver

Längstraverse | Traverse centrale | Central bar

**Für Betten ab Breite 140 cm mit 2 Lattenrosten oder Motorrahmen-einbau** | Pour les lits à partir de 140 cm de largeur avec 2 sommiers ou l'installation d'un cadre motorisé | For beds from 140 cm width with 2 slats or motor frame installation

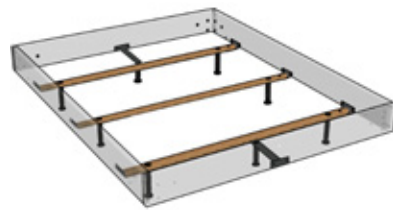

## Crosstraver-XXL

Quertraversen | Traverses transversales | Cross bars

**Für alle Bettbreiten** | Pour toutes les largeurs de lit | For all bed widths

**Übersicht Kompatibilität Traversen siehe Gesamtkatalog Seite 2.12** | Aperçu compatibilité traverses voir catalogue général page 2.12 | Overview compatibility bars see general catalogue page 2.12

## \* Connecto 23

**Bei der Einlegetiefe 18 cm sind die Füße/Sockel um 5 cm versenkt und um diese Höhe weniger sichtbar.**

Avec les équerres en position haute (18 cm) les pieds/socle sont encastrés de 5 cm sous le cadre et donc moins visibles.

With the insertion depth 18 cm the feet/socket are sunken in by 5 cm and this height less visible.

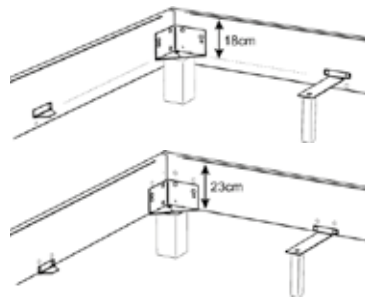

## Option Midtraver-move + Evio

**Achtung: nicht bei Füßen in der Höhe 30 cm, Lovie-Box und Practico-Box einsetzbar**

Attention : ne s'applique pas aux pieds à une hauteur de 30 cm, Lovie-Box et Practico-Box

Attention: not applicable for feet at a height of 30 cm, Lovie-Box and Practico-Box

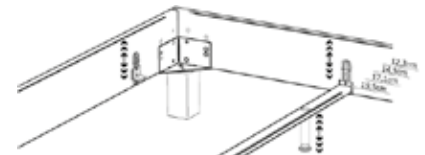

## Ausführungen | Exécutions | Executions

### Holz | Bois | Wood

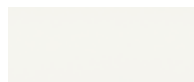

**10**  
**Buche weiss deckend, lackiert**  
Hêtre blanc couvrant, laqué  
Beech white covered, lacquered



**16**  
**Buche anthracit deckend, lackiert**  
Hêtre anthracite couvrant, laqué  
Beech anthracit covered, lacquered



**87**  
**Wildbuche natur, geölt**  
Hêtre nouveau naturel, huilé  
Wildbeech natural, oiled



**96**  
**Wildeiche pure, gebürstet, geölt**  
Chêne nouveau pure, brossé, huilé  
Wildoak pure, brushed, oiled

# Füsse | Pieds | Feet



## Holz | Bois | Wood



### Holz | Bois | Wood

	Breiten cm Largeurs cm Widths cm	Höhen cm Hauteurs cm Heights cm			Holzfarben Couleurs bois Colours wood			
		20	25	30	10	16	87	96
Gola		●	●				●	●
Evio	140-200		●				●	●
Ivio		●	●	●			●	●
Lovie-Box	140-200		●				●	●
Practico Box* (inkl. Boden/fond inclus/ bottom included)	140-200		●		●	●		
Skid	140-200		●				●	●

\*weiss/anthrazit = MDF | blanc/anthracite = MDF | white/anthracite = MDF

## Metall | Métal | Metal

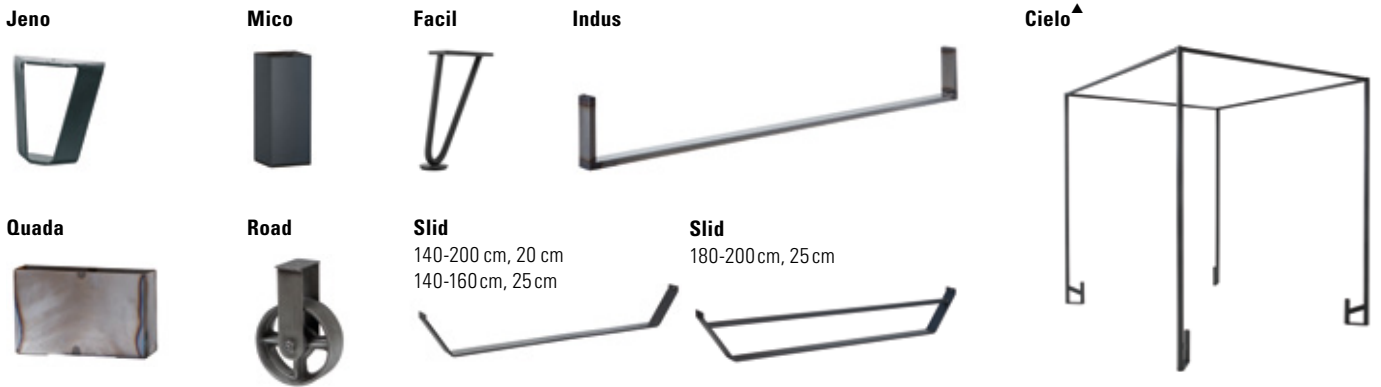

### Metall | Métal | Metal

	Masse cm Dimensions cm	Breiten cm Largeurs cm Widths cm	Höhen cm Hauteurs cm Heights cm				Metallfarben Couleurs métal Colours metal							
			10	20	25	30	00	04	10	16	42	43	45	
Cielo <sup>▲</sup>		140-200		●				●	●					
Facil				●					●					
Indus		140-200							●					●
Jeno	12x5		●	●	●				●					
Mico	8x8		●	●	●	●		●		●	●	●	●	●
Quada	20x6,5			●	●									●
Road*	Ø 13			●				●						
Slid	8/1	140-200		●	●			●	●	●				

\*Füsse fixiert, Rollen nur optisch | Pieds fixes, roulettes uniquement décoration | Feet fixed, castors only visua

<sup>▲</sup>Curty Vorhang und Vela Baldachin-Tuch siehe Gesamtkatalog Register 2, Seite 12 | Curty rideau et Vela tissu de baldaquin voir catalogue général registre 2, page 12 | Curty curtain and Vela canopy cloth see general catalogue index 2, page 12



**00 Chrom = Metall verchromt** | Métal chromé | Metal chrome  
**04 Used = Metall galvanisiert** | Métal galvanisé | Metal galvanised  
**10 White = Metall pulverbeschichtet** | Métal thermolaqué | Metal powder-coated  
**16 Anthracit = Metall pulverbeschichtet** | Métal thermolaqué | Metal powder-coated

**42 Alu = Stahl pulverbeschichtet** | Acier thermolaqué | Steel powder-coated  
**43 Inox = Edelstahl geschliffen** | Acier inoxydable poncé | Stainless steel ground  
**45 Iron = Metall geflammt, pulverbeschichtet** | Métal flammé, thermolaqué | Metal mottled, powder-coated

# Kopfteile | Têtes de lit | Headboards



## Bordo



**Dimension:** 140, 160, 180, 200

## Naturo L



**Dimension:** 140, 160, 180, 200

## Bretto



**Dimension:** 140, 160, 180, 200

## Adapter | Adaptateur | Adapter

**Bei hohen Matratzen kann mit dem Verlängerungsadapter das Kopfteil erhöht werden.**

La tête de lit peut être rehaussée avec l'adaptateur lorsque le matelas est plus épais.

With the extension adapter the headboard can be extended if mattresses are high.

**Head-Plus** (2er Set | set de 2 | set of 2)

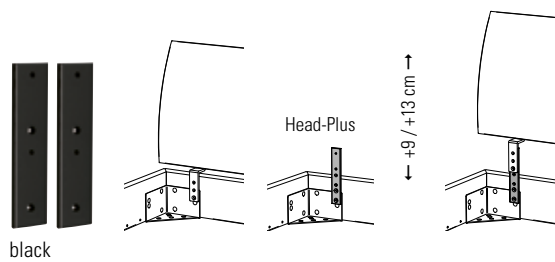

## Leselampe | Lampe de lecture | Reading lamp

**Leselampe bei Holz- und gepolsterten Kopfteilen montierbar**

La lampe de lecture peut être montée sur des têtes de lit en bois et rembourrée

Reading lamp can be assembled on wooden an upholstered headboards

**Smart black** (2er Set | set de 2 | set of 2)



**Weitere Leselampen und technische Details siehe Gesamtkatalog Register 2, Seite 2.11**

Autres lampes de lecture et détails techniques voir catalogue général registre 2, page 2.11

Further reading lamps and technical details see general catalogue index 2, page 2.11

## Ausführungen | Exécutions | Executions

### Holz | Bois | Wood



**87 Wildbuche natur, geölt**  
Hêtre nouveau naturel, huilé  
Wildbeech natural, oiled

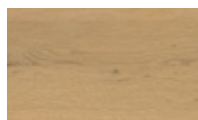

**96 Wildeiche pure, gebürstet, geölt**  
Chêne nouveau pure, brossé, huilé  
Wildoak pure, brushed, oiled



# Kissen zu Kopfteilen | Coussins pour têtes de lit | Cushions for headboards

**Arona + Naturo L**



**Lumo + Naturo L**



**Ravo + Bordo**



**Suny + Bordo**



**Varo + Bretto**



**Alle Kissen in Echtleder haben Zier- sowie Teilungsnahte. Ausnahmen: Suny und Varo, diese Kissen haben lediglich Ziernahte.** | Tous les coussins en cuir véritable ont des coutures décoratives et des coutures de séparation. A l'exception des coussins : Suny et Varo, ces coussins ont uniquement des coutures décoratives. | All cushions in genuine leather have decorative and dividing seams. Exceptions: Suny and Varo, these cushions only have decorative seams.

## Kissen | Coussins | Cushions

### Effektive Masse cm

Dimensions effectives cm  
Effective dimensions cm

Arona	136, 156, 176×3,5×25
Lumo	136, 156, 176×6×25
Ravo	130, 150, 170, 190×3,5×35
Suny (2er Set   set de 2   set of 2)	55×6×40
Varo (2er Set   set de 2   set of 2)	55×10×35

### zu Kopfteilen

pour têtes de lit  
for headboards

Bordo	Bretto	Naturo
		●
		●
●	●	
●		
●	●	

### Breitenmasse cm

Dimensions de largeur cm  
Widths dimensions cm

140, 160, 180/200
140, 160, 180/200
140, 160, 180, 200

## gepolstert | rembourrées | upholstered

**Suno**



**Ripo**

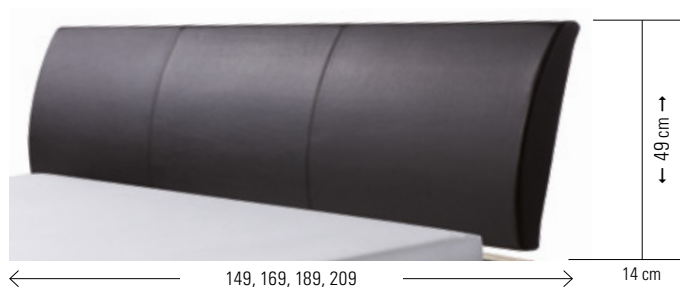

**Dimension:** 140, 160, 180, 200

**Dimension:** 140, 160, 180, 200

**Weitere gepolsterte Kopfteile, Wandpaneele, Stoffauswahl/Farben siehe Gesamtkatalog Register 1, Leselampen siehe Gesamtkatalog Register 2**

Autres têtes de lits rembourrées, panneaux muraux, choix de tissus/couleurs voir catalogue général registre 1, lampes de lecture voir catalogue général registre 2  
Further upholstered headboards, wallpanels, choice of tissues/colours see general catalogue index 1, reading lamps see general catalogue index 2



				<b>Dimension cm</b>
<b>Naturo L</b>	Kopfteil	Tête de lit	Headboard	140, 160, 180, 200
<b>Arona</b>	Kissen, Casual carbon 334	Coussin, Casual carbon 334	Cussion, Casual carbon 334	140, 160, 180/200
<b>Smart black</b>	Leselampe (2er Set), weiss 12V DC, 30 LED warm Dreistufenschaltung	Lampe de lecture (set de 2), blanc 12V DC, 30 LED warm interrupteur à 3 crans	Reading lamp (set of 2), white 12V DC, 30 LED warm three step circuit	
<b>Bordo</b>	Kopfteil	Tête de lit	Headboard	140, 160, 180, 200







				<b>Dimension cm</b>
<b>Connecto 23</b>	Rahmen Breiten Längen	Cadre Largeurs Longueurs	Frame Widths Lengths	140, 160, 180, 200 200, 210, 220
<b>Gola</b>	Füße Höhen	Pieds Hauteurs	Feet Heights	20, 25
<b>Naturo L</b>	Kopfteil	Tête de lit	Headboard	140, 160, 180, 200
<b>Caja</b>	Nachttisch	Table de nuit	Bedside table	48/41/16

**Alle Holzteile in Wildbuche natur, geölt**

Toutes les parties en bois en hêtre nouveau naturel, huilé  
All wooden parts in wildbeech natural, oiled

**Leselampen und weitere Beimöbel siehe Gesamtkatalog Register 2**

Lampes de lecture et autres accessoires voir catalogue général registre 2  
Reading lamps and further accessories see general catalogue index 2

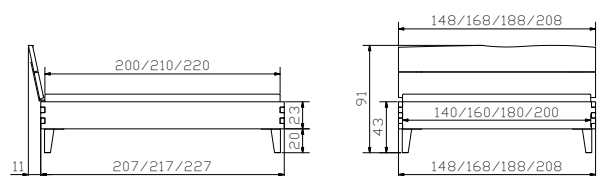





**Vera**  
**Cua 7**

Nachttisch  
Füsse

Table de nuit  
Pieds

Bedside table  
Feet

**Dimension cm**  
50/40/43

**Alle Holzteile in Wildeiche pure, gebürstet, geölt** | Toutes les parties en bois en chêne nouveau pure, brossé, huilé | All wooden parts in wildoak pure, brushed, oiled  
**Weitere Beimöbel siehe Gesamtkatalog Register 2** | Autres accessoires voir catalogue général registre 2 | Further accessories see general catalogue index 2





				<b>Dimension cm</b>
<b>Connecto 23</b>	Rahmen Breiten Längen	Cadre Largeurs Longueurs	Frame Widths Lengths	140, 160, 180, 200 200, 210, 220
<b>Gola</b>	Füße Höhen	Pieds Hauteurs	Feet Heights	20, 25, 30
<b>Bretto</b>	Kopfteil	Tête de lit	Headboard	140, 160, 180, 200

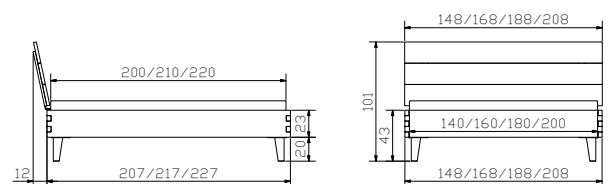





**Snake** alu

Leselampe (2er Set)  
12V DC, 6 LED

Lampe de lecture (set de 2)  
12V DC, 6 LED

Reading lamp (set of 2)  
12V DC, 6 LED

**Dimension cm**



**Caja**

Nachttisch

Table de nuit

Bedside table

48/41/16

**Alle Holzteile in Wildeiche pure, gebürstet, geölt** | Toutes les parties en bois en chêne nouveau pure, brossé, huilé | All wooden parts in wildoak pure, brushed, oiled  
**Leselampen und weitere Beimöbel siehe Gesamtkatalog Register 2** | Lampes de lecture et autres accessoires voir catalogue général registre 2 | Reading lamps and further accessories see general catalogue index 2





				Dimension cm
<b>Connecto 23</b>	Rahmen Breiten Längen	Cadre Largeurs Longueurs	Frame Widths Lengths	140, 160, 180, 200 200, 210, 220
<b>Skid</b>	Kufen Breiten Höhe	Patins Largeurs Hauteur	Vats Widths Height	140, 160, 180, 200 25
<b>Naturo L</b>	Kopfteil	Tête de lit	Headboard	140, 160, 180, 200
<b>Cassetto</b>	Kommode	Commode	Chest of drawers	105/46/77

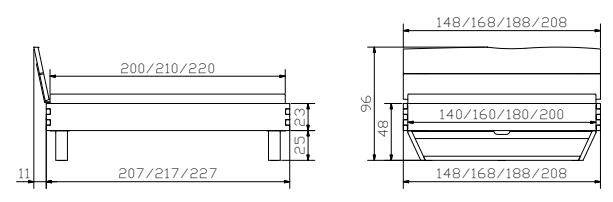





**MOVIE-/TOP LINE**



**FACTORY LINE**



**WOOD LINE**



**LOUNGE**



**FINE LINE**



**NATURO LINE**



**OAK LINE**



**OAK WILD**



**DREAM LINE**



**EDITION  
BOXSPRING**



**FUNCTION/COMFORT  
KIDS & GUESTS**



**LATTENROSTE &  
MATRATZEN**



**Gesamtkatalog**  
Catalogue général  
General catalogue



**Schlafwohl**

Markenmatratzen & Bettsysteme