



swiss bed concept



Schlafwohl

Markenmatratzen & Bettsysteme



FACTORY LINE

AKAZIE & EICHE MASSIV | ACACIA & CHENE MASSIF | ACACIA & OAK SOLID

Achten Sie auf FSC®-zertifizierte Produkte | Soyez attentifs aux produits certifiés FSC® | Look for FSC®-certified products



Hasena – mein Bett

Hasena – mon lit | Hasena – my bed

Beständige Passion

Une passion constante
Enduring Passion



Mehr als ein Lebenswerk

Als Familienunternehmen gegründet, überzeugen wir seit über 70 Jahren mit hoher Qualität und Vielseitigkeit im Bereich Schlafzimmermöbel.

Plus que l'œuvre d'une vie

Fondée en tant qu'entreprise familiale, nous convainquons depuis plus de 70 ans par notre qualité élevée et notre polyvalence dans le domaine des meubles de chambre à coucher.

More than a life's work

Founded as a family business, we have been impressing with high quality and versatility in the field of bedroom furniture for over 70 years.

swiss bed concept



swiss bed concept

Ein cleveres Baukastensystem

Sie wählen Ihren favorisierten Bettrahmen aus und kombinieren dazu Füße und Kopfteil Ihrer Wahl. Dabei können Sie quer durch die Kollektionen auf unterschiedliche Materialien und Farben zugreifen.

Un système modulaire astucieux

Vous choisissez votre cadre de lit préféré et le combinez avec les pieds et les têtes de lit de votre choix. Vous pouvez choisir parmi une variété de matériaux et de couleurs dans toutes les collections.

A clever modular system

You choose your favourite bed frame and combine it with the feet and headboards of your choice. You can choose from a variety of materials and colours throughout the collections.

5 Jahre Garantie

Service de livraison rapide
5 years warranty



Unser Versprechen

Vom Baum zum Bett – mittels handwerklicher Perfektion und hochwertigen Materialien. Sie erhalten 5 Jahre Garantie auf die Material- und Oberflächenbeschaffenheit, sowie die fachgerechte Verarbeitung aller Modelle ab Kaufdatum. Weitere Informationen finden Sie auf unserer Website.

Notre promesse

De l'arbre au lit – grâce à un artisanat parfait et des matériaux de haute qualité. Vous bénéficiez d'une garantie de 5 ans sur la qualité des matériaux et des surfaces, ainsi que sur la fabrication professionnelle de tous les modèles à compter de la date d'achat. Vous trouverez plus d'informations sur notre site Internet.

Our promise

From tree to bed – by means of perfect craftsmanship and high-quality materials. You receive a 5-year guarantee on the material and surface quality, as well as the professional workmanship of all models from the date of purchase. Further information can be found on our website.

Schnellieferservice

Service de livraison rapide
Quick delivery service



Komfort ohne Wartezeit

Mit unserem Schnellieferservice «PRONTO» können wir eine grosse Auswahl an Betten mit Beimöbeln und alle Modelle aus Edition pronto, Dream pronto und Boxspring pronto ab Lager liefern.

Le confort sans attente

Notre service de livraison rapide « PRONTO » permet de livrer un large choix de lits, de meubles d'appoint et tous les modèles de l'Édition Pronto, Dream pronto et Boxspring Pronto à partir du stock.

Comfort without waiting

With our quick delivery service «PRONTO» we can offer a large selection of beds with ancillary furniture and all models from models from Edition pronto, Dream pronto and Boxspring pronto from stock.





Vielseitig kombinierbar

Unser ausgeklügeltes Baukastensystem «swiss bed concept» bietet eine riesige Auswahl an Füßen, Kopfteilen und Beimöbeln. Darüber hinaus umfasst es verschiedene Stoff-, Kunstleder- und Lederbezüge sowie diverse Holz- und Metallausführungen. Abgestimmte Lattenroste und Matratzen komplettieren unsere Betten zur Wohlfühloase.

Combinable à versatile

Notre système modulaire sophistiqué «swiss bed concept» propose un choix énorme de pieds, têtes de lits et accessoires. Par ailleurs le comporte différents tissus, cuirs synthétiques et véritables, ainsi que diverses variantes de bois et métal. Des sommiers à lattes et des matelas adaptés complètent nos lits pour un espace bien-être.

Versatile combinable

Our ingenious modular system «swiss bed concept» offers a huge selection of feet, headboards and accessories. In addition, it includes different fabrics, synthetic leather and real leather covers and different wood and metal versions. Matching slatted frames and mattresses complete our beds to an oasis of well-being.

Nachhaltigkeit bei Hasena

Unser wichtigster Lieferant, die Natur, ist sensibel und benötigt lange Regenerationszeiten bei Überbeanspruchung. Wir respektieren die von uns genutzten Ökosysteme und stellen unsere Produkte nachhaltig und mit hohem sozialen Engagement her.



Soziale Verantwortung

Responsabilité sociale
Social responsibility



Holzoberflächen

Surfaces en bois
Wood surfaces



Stabil im Aufbau

Unsere Betten überzeugen durch eine hohe Stabilität. Mittels Einsatz verschiedener Traversen ist eine gesamthafte Belastung von 300 bis 450 kg, inklusive Lattenroste und Matratzen, möglich.

Construction robuste

Nos lits sont convainçants par leur grande stabilité. En utilisant différentes fermes, une charge totale de 300 à 450 kg, y compris les sommiers à lattes et les matelas, est possible.

Solid in construction

Our beds convince with their high stability. By using different trusses, a total load of 300 to 450 kg, including slatted frames and mattresses, is possible.

Durabilité chez Hasena

Notre fournisseur le plus important, la nature, est sensible et nécessite un long temps de régénération en cas de surutilisation. Nous respectons les écosystèmes que nous utilisons et fabriquons nos produits de manière durable et avec un haut niveau d'engagement social.



Holzbeschaffung

Approvisionnement en bois
Wood procurement



Recycelte Stoffe

Tissus recyclés
Recycled fabrics



Einfach in der Montage

Unser Betten-System begeistert durch einen einfachen Aufbau mit leicht verständlicher Montageanleitung sowie hochwertigen Verbindungselementen, welche einen vielfachen Ab- und Wiederaufbau ermöglichen.

Montage facile

Notre système de lits séduit par une installation facile grâce aux instructions de montage bien compréhensibles ainsi que par les éléments de fixation haut de gamme permettant de monter et démonter les lits à de nombreuses reprises.

Solid in construction

Our beds convince with their high stability. By using different trusses, a total load of 300 to 450 kg, including slatted frames and mattresses, is possible.

Sustainability at Hasena

Our most important supplier, nature, is sensitive and needs long regeneration times in case of overuse. We respect the ecosystems we use and manufacture our products sustainably and with a high level of social commitment.



Produktion Massivholz

Production bois massif
Manufacturing solid wood



Energiegewinnung

Production énergétique
Production of energy



Bettrahmen | Cadre de lit | Bedframe

Bloc 16



Breiten | Largeurs | Widths:
140, 160, 180, 200 cm

Längen | Longueurs | Lengths:
200, 210, 220 cm

Einlegetiefe | Hauteur encastrable | Insertion depth:
16 cm

Loft 18



Breiten | Largeurs | Widths:
90, 100, 120, 140, 160, 180, 200 cm

Längen | Longueurs | Lengths:
200, 210, 220 cm

Einlegetiefe | Hauteur encastrable | Insertion depth:
18 cm

Cone 23



Breiten | Largeurs | Widths:
140, 160, 180, 200 cm

Längen | Longueurs | Lengths:
200, 210, 220 cm

Einlegetiefe | Hauteur encastrable | Insertion depth:
18*, 23 cm

Option

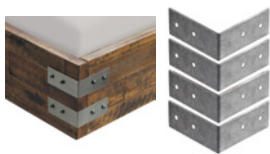

Case 8

Winkel (8er Set zu Loft und Cone Bettrahmen)

Équerres (set de 8 pour cadre de lit Loft et Cone)

Bracket (set of 8 for Loft and Cone bedframe)

Holz | Bois | Wood

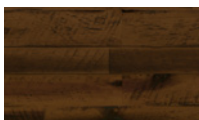

62 Akazie Vintage brown, lackiert

Acacia Vintage brown, laqué
Acacia Vintage brown, lacquered



64 Akazie Vintage grey, lackiert

Acacia Vintage grey, laqué
Acacia Vintage grey, lacquered



70 Eiche uniq clear, geölt

Chêne uniq clear, huilé
Oak uniq clear, oiled

Hergestellt aus recyceltem Holz

Fabriqué en bois recyclé

Made of recycled wood



No time to waste – Nachhaltigkeit bei Hasena



Le développement durable chez Hasena
Sustainability at Hasena

Unter Pre-Consumer-Recycling versteht man die Rückgewinnung von Abfallstoffen, die bei der Herstellung oder Lieferung von Waren vor der Auslieferung an den Verbraucher anfallen. Recycelte Materialien können zerlegt und in ähnliche oder andere Materialien umgewandelt werden. Denken Sie an die Schnittverluste bei der Herstellung oder an die Holzabfälle, die bei der Möbelproduktion anfallen.

Le recyclage pré-consommation désigne la récupération des déchets générés lors de la production ou de la livraison de marchandises avant leur livraison au consommateur. Les matériaux recyclés peuvent être démontés et transformés en matériaux similaires ou différents. Pensez aux pertes de coupe lors de la fabrication ou aux déchets de bois générés par la production de meubles.

Pre-consumer recycling is the recovery of waste materials generated during the manufacture or supply of goods before delivery to the consumer. Recycled materials can be broken down and transformed into similar or other materials. Think of the cutting losses during manufacturing or the wood waste generated during furniture production.

Mehr über Nachhaltigkeit siehe Gesamtkatalog auf Seiten 4-7

Pour en savoir plus sur la durabilité voir catalogue général pages 4-7
More about sustainability see general catalogue on pages 4-7

Traversen | Traverses | Bars

Wir empfehlen grundsätzlich den Einsatz von Crosstraver (Quertraverse) oder Midtraver (Längstraverse).

Nous recommandons en général l'utilisation de Crosstraver (traverse transversale) ou Midtraver (traverse centrale).

We recommend basically the insertion of Crosstraver (central cross bar) or Midtraver (central bar).

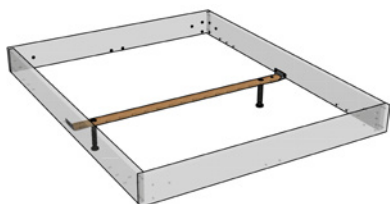

Crosstraver

Quertraverse | Traverse transversale | Central cross bar

Für alle Bettbreiten | Pour toutes les largeurs de lit | For all bed widths

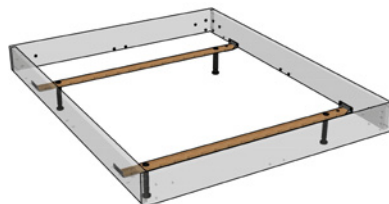

Crosstraver-Twin

Quertraversen | Traverses transversales | Cross bars

Für alle Bettbreiten | Pour toutes les largeurs de lit | For all bed widths

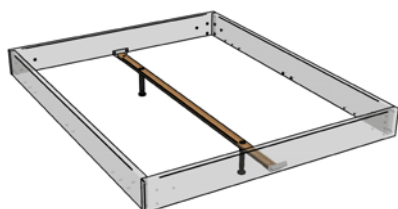

Midtraver

Längstraverse | Traverse centrale | Central bar

Für Betten ab Breite 140 cm mit 2 Lattenrosten oder Motorrahmen-einbau | Pour les lits à partir de 140 cm de largeur avec 2 sommiers ou l'installation d'un cadre motorisé | For beds from 140 cm width with 2 slats or motor frame installation

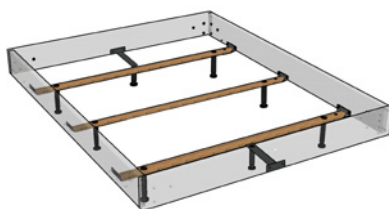

Crosstraver-XXL

Quertraversen | Traverses transversales | Cross bars

Für alle Bettbreiten | Pour toutes les largeurs de lit | For all bed widths

Übersicht Kompatibilität Traversen siehe Gesamtkatalog Seite 2.12 | Aperçu compatibilité traverses voir catalogue général page 2.12 | Overview compatibility bars see general catalogue page 2.12

* Cone 23

Bei der Einlegetiefe 18 cm sind die Füße/Sockel um 5 cm versenkt und um diese Höhe weniger sichtbar.

Avec les équerres en position haute (18 cm) les pieds/socle sont encastrés de 5 cm sous le cadre et donc moins visibles.

With the insertion depth 18 cm the feet/socket are sunken in by 5 cm and this height less visible.

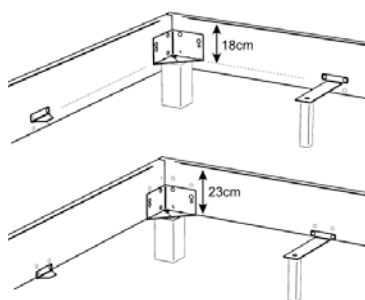

Option Midtraver-move

Achtung: nicht bei Füßen in der Höhe 30 cm, Lovie-Box und Practico-Box einsetzbar

Attention : ne s'applique pas aux pieds avec une hauteur de 30 cm, Lovie-Box et Practico-Box
Attention: not applicable for feet at a height of 30 cm, Lovie-Box and Practico-Box

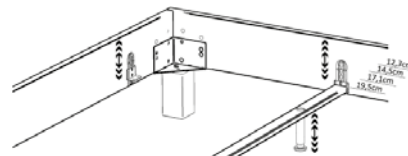

Urbanes Flair

Robust, schroff, mit dekorativen Metallbeschlägen und natürlichen Unregelmäßigkeiten: der unkonventionelle Fabrikhallen-Stil unserer Factory-Line taucht jedes Schlafzimmer in ein aussergewöhnlich urbanes Flair.

Alle Holzteile werden aus massiver Akazie oder Eiche gefertigt. Sie besitzt eine hohe Widerstandsfähigkeit und ist dadurch ein sehr dauerhaftes Holz. Neben dieser Robustheit verfügen Akazie oder Eiche über eine unvergleichliche Elastizität; Rissbildungen und Verziehen des Holzes kommen sehr selten vor. Bitte beachten Sie, dass Farb- und Strukturunterschieden bei Echtholz naturbedingte Eigenschaften sind.

Ambiance urbaine

Robuste, rugueux, avec des ferrures décoratives en métal et des irrégularités naturelles : le style non conventionnel du hall d'usine de notre Factory-Line plonge chaque chambre dans une ambiance urbaine extraordinaire.

Toutes les pièces en bois sont en acacia ou chêne massif. Il a une haute résistance et est donc un bois très durable. En plus de cette robustesse, l'acacia et le chêne possèdent une élasticité incomparable ; les fissures et les déformations du bois sont très rares. Veuillez noter que les différences de coloris et de structures sont des caractéristiques naturelles du bois.

Urban flair

Robust, rugged, with decorative metal fittings and natural irregularities: the unconventional factory hall style of our Factory-Line immerses every bedroom in an extraordinary urban flair.

All wooden parts are made of solid acacia or oak. It has a high resistance and is therefore a very durable wood. In addition to this robustness, acacia and oak have an incomparable elasticity; cracking and warping of the wood occur very rarely. Please note that differences in colour and texture are natural features of real wood.

Füsse | Pieds | Feet



Holz | Bois | Wood

Gola



Ivio



Practico-Box



Stabil



Evio



Vilo



Lovie-Box

90–140 (1 Schublade/Tiroir/Drawer)

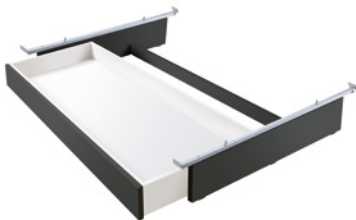

Lovie-Box

140–200 (2 Schubladen/Tiroirs/Drawers)

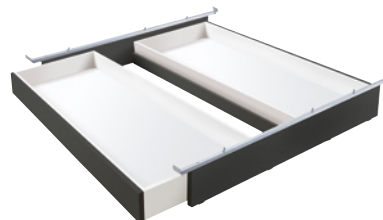

Standard: gedämpfter Selbstezug
Blumotion von BLUM

Option: Tip-On-Öffnung mit Vollauszug von BLUM

Standard: système d'amortissement
Blumotion de BLUM

Option: ouverture Tip-On avec sortie totale de BLUM

Standard: soft closing runner Blumotion of BLUM

Option: opening Tip-On with full extension of BLUM

Holz | Bois | Wood

	Masse cm Dimensions cm	Breiten cm Largeurs cm Widths cm	Höhen cm Hauteurs cm Heights cm				Holzfarben Couleurs bois Colours wood				
			10	20	25	30	10	16	62	64	70
Evio		90–200			●		●				
Gola	8/5×8/5			●	●			●	●	●	
Ivio	10×10		●	●	●			●	●	●	
Lovie-Box* (1 Schublade/Tiroir/Drawer)		90–140			●		●	●			
Lovie-Box* (2 Schubladen/Tiroirs/Drawers)		140–200			●		●	●			
Practico-Box (inkl. Boden Fond inclus Bottom included)		90–200			●		●				
Stabil**		140–200			●			●	●	●	
Vilo		90–200		●			●	●		●	

*bei Cone 23 Rahmen nur mit Einlegetiefe 23 cm möglich | avec cadre Cone 23 uniquement possible avec la hauteur encastrable de 23 cm | with Cone 23 frame only possible with insertion depth 23 cm

**Stabil nur mit Bloc 16 Rahmen möglich | Stabil uniquement possible avec cadre de lit Bloc16 | Stabil only possible with frame Bloc 16

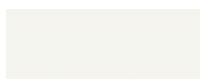

10
Weiss
Blanc
White



16
Anthracit

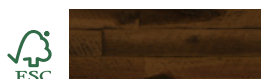

62
**Akazie Vintage brown,
lackiert**
Acacia Vintage brown,
laqué
Acacia Vintage brown,
lacquered



64
**Akazie Vintage grey,
lackiert**
Acacia Vintage grey,
laqué
Acacia Vintage grey,
lacquered



70
Eiche uniq clear, geölt
Chêne uniq clear, huilé
Oak uniq clear, oiled
Hergestellt aus recyceltem Holz
Fabriqué en bois recyclé
Made of recycled wood
(Seite/page 5.2)

Füsse | Pieds | Feet

Metall | Métal | Metal

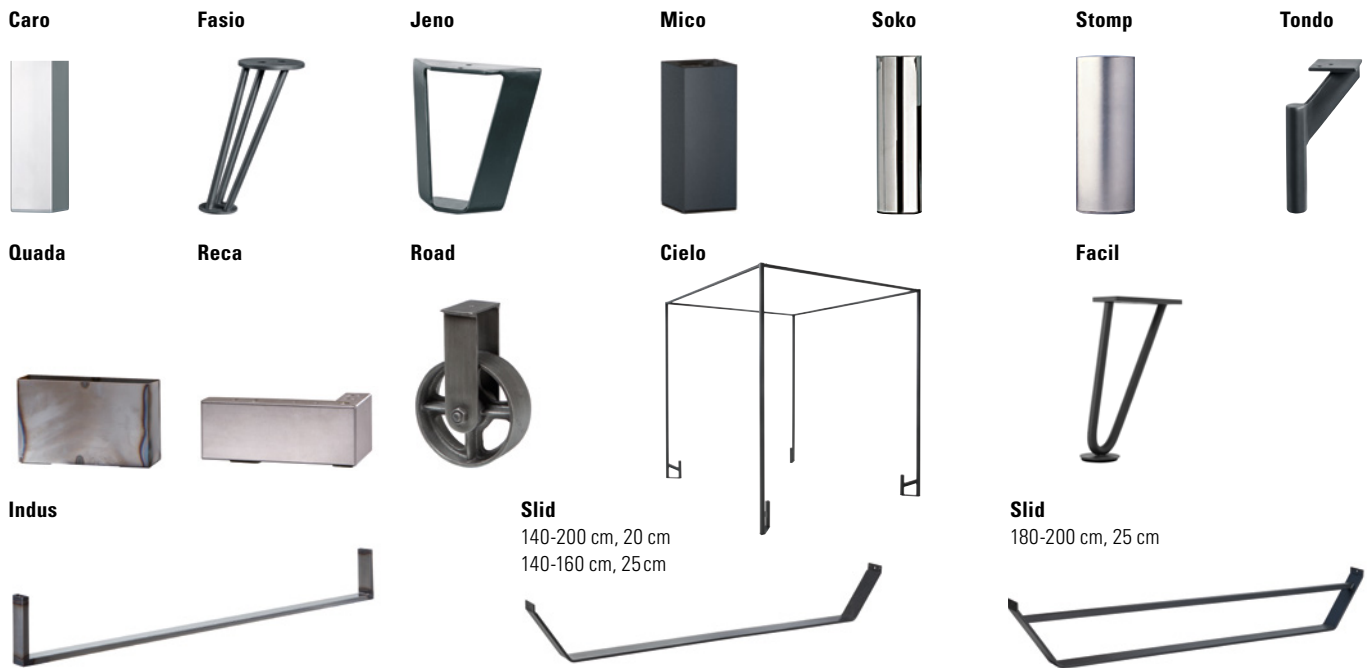

Metall | Métal | Metal

	Masse cm Dimensions cm	Breiten cm Largeurs cm Widths cm	Höhen cm Hauteurs cm Heights cm				Metallfarben Couleurs métal Colours metal								
			10	20	25	30	00	04	10	16	40	41	42	43	45
Caro	6×6			●	●		●			●		●			●
Cielo**▲		120-200		●				●							
Facil				●					●						
Fasio	∅ 5/9			●					●	●	●				
Indus	6×2	140-200		●	●				●						●
Jeno	12×5		●	●	●			●		●					
Mico	8×8		●	●	●	●		●		●		●	●	●	
Quada	20×6,5			●	●										●
Reca	24×12		●										●		
Road*	∅ 13			●					●						
Slid	8/1	140-200		●	●				●				●		
Soko	∅ 6			●	●			●					●		
Stomp	∅ 8		●	●	●	●		●					●		
Tondo	∅ 3,5			●						●			●		

*Füsse fixiert, Rollen nur optisch | Pieds fixes, roulettes uniquement décoratives | Feet fixed, castors only visual

▲ Curty Vorhang und Vela Baldachin-Tuch siehe Gesamtkatalog Register 2, Seite 12 | Curty rideau et Vela tissu de baldachin voir catalogue général registre 2, page 12 | Curty curtain and Vela canopy cloth see general catalogue index 2, page 12

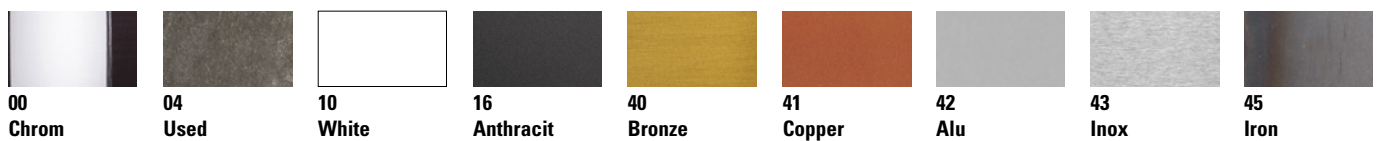

00 Chrom = Edelstahl poliert | Acier poli | Stainless steel polished

04 Used = Stahl galvanisiert | Acier galvanisé | Steel galvanised

10 White = Stahl pulverbeschichtet | Acier thermolaqué | Steel powder-coated

16 Anthracit = Stahl pulverbeschichtet | Acier thermolaqué | Steel powder-coated

40 Bronze = Stahl lackiert | Acier laqué | Steel lacquered

41 Copper = Stahl lackiert | Acier laqué | Steel lacquered

42 Alu = Stahl pulverbeschichtet | Acier thermolaqué | Steel powder-coated

43 Inox = Edelstahl geschliffen | Acier inoxydable poncé | Stainless steel ground

45 Iron = Metall geflammt, pulverbeschichtet | Métal flammé, thermolaqué | Metal mottled, powder-coated

Kopfteile | Têtes de lit | Headboards



Arcada 



Dimension: 90/100, 120, 140, 160, 180, 200

Varus 



Dimension: 140, 160, 180, 200

Inca*



*nur mit Bettrahmen Bloc 16 möglich | uniquement possible avec cadre de lit Bloc 16 | only possible with bed frame Bloc 16

Dimension: 140/160, 180/200

Gepolsterte Kopfteile, Wandpaneele, Stoffauswahl/Farben siehe Gesamtkatalog Register 1, Leselampen siehe Gesamtkatalog Register 2.

Têtes de lits rembourrées, panneaux muraux, choix de tissus/couleurs voir catalogue général registre 1, lampes de lecture voir catalogue général registre 2.

Upholstered headboards, wallpanels, choice of tissues/colours see general catalogue index 1, reading lamps see general catalogue index 2.



Ausführungen | Exécutions | Executions

Holz | Bois | Wood



62
Akazie Vintage brown, lackiert

Acacia Vintage brown, lacqué
Acacia Vintage brown, lacquered



64
Akazie Vintage grey, lackiert

Acacia Vintage grey, lacqué
Acacia Vintage grey, lacquered



70
Eiche uniq clear, geölt

Chêne uniq clear, huilé
Oak uniq clear, oiled
Hergestellt aus recyceltem Holz
Fabriqué en bois recyclé
Made of recycled wood
(Seite/page 4)



Adapter | Adaptateur | Adapter

Bei hohen Matratzen kann mit dem Verlängerungsadapter das Kopfteil erhöht werden.

La tête de lit peut être rehaussée avec l'adaptateur lorsque le matelas est plus épais.

With the extension adapter the headboard can be extended if mattresses are high.

Head-Plus

Metall | Métal | Metal



black

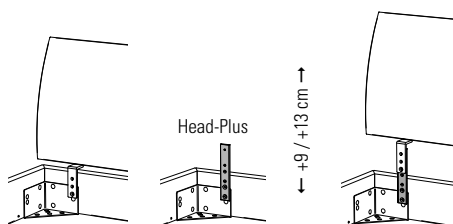

Balco-Hold L (Inca)

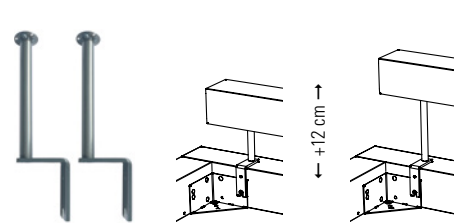

iron

Kissen und Kopfteile gepolstert | Coussins et têtes de lit capitonnées | Cushions and headboards upholstered

Arona + Arcada



Lumo + Arcada



Nakio + Inca



Ravo + Varus



Suny + Varus



Varo + Varus



Befestigung mit 2 Bändern (Klettverschluss)

Fixation avec 2 bandes (Velcro®)

Fixation with 2 ribbons (Velcro®fastener)

Kissen | Coussins | Cushions

Effektive Masse cm

Dimensions effectives cm
Effective dimensions cm

Arona	86, 116, 136, 156, 176×3,5×25
Lumo	86, 116, 136, 156, 176×6×25
Nakio (2er Set Set de 2 Set of 2)	55×18×14
Ravo	80, 110, 130, 150, 170, 190×3,5×35
Suny (2er Set Set de 2 Set of 2)	55×6×40
Varo (2er Set Set de 2 Set of 2)	55×10×35

zu Kopfteilen pour têtes de lit for headboards

Arcada	Varus	Inca
●		
●		
		●
●	●	
●	●	
●	●	

Breitenmasse cm

Dimensions de largeur cm
Widths dimensions cm

90/100, 120, 140, 160, 180/200
90/100, 120, 140, 160, 180/200
90/100, 120, 140, 160, 180, 200

Alle Kissen in Echtleder haben Zier- sowie Teilungsnähte. Ausnahmen: Nakio, Suny und Varo, diese Kissen haben lediglich Ziernähte. | Tous les coussins en cuir véritable ont des coutures décoratives et des coutures de séparation. A l'exception des coussins : Nakio, Suny et Varo, ces coussins ont uniquement des coutures décoratives. | All cushions in genuine leather have decorative and dividing seams. Exceptions: Nakio, Suny and Varo, these cushions only have decorative seams.

Dorma*



← 140, 160, 180, 200 →

Dimension: 140, 160, 180, 200

Das Kopfteil Dorma enthält in Echtleder keine Teilungsnähte. | En cuir véritable, la tête de lit Dorma ne comporte pas de coutures de séparation. | The Dorma headboard contains no dividing seams in genuine leather.

Opera*



← 166, 186, 206, 226 →

Dimension: 140, 160, 180, 200

*nur mit Betrahmen Bloc möglich | uniquement possible avec cadre de lit Bloc | only possible with bed frame Bloc

selezione

01

MODELLAUSWAHL

Sélection du modèle | Model selection

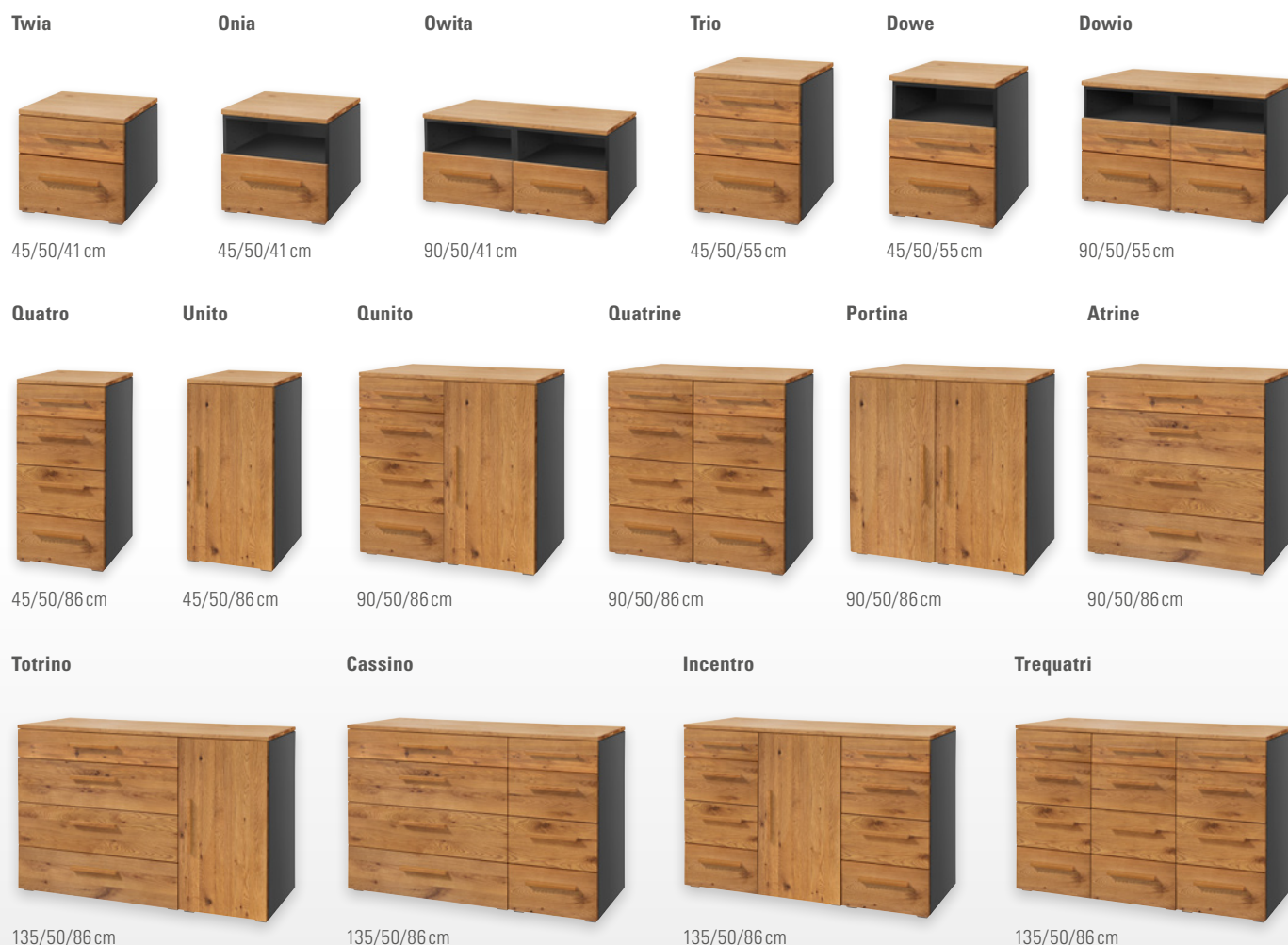
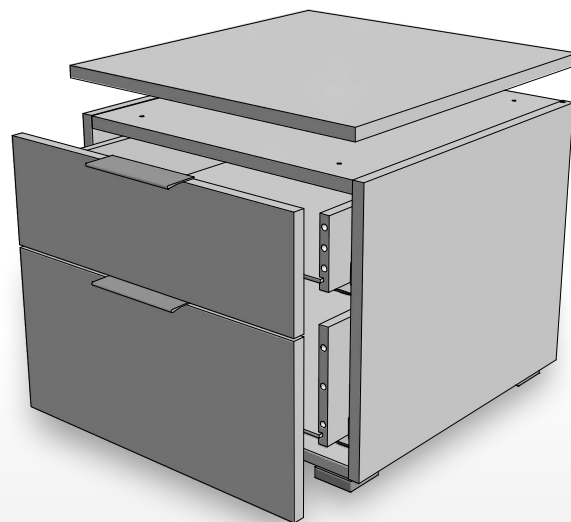

Stellen Sie sich Ihr Wunsch-Beimöbel nach Ihrem Geschmack zusammen: Der Korpus (Abb. 02), in zwei verschiedenen Farbvarianten, lässt sich zu den Front- und Top-Covern (Abb. 03) in acht Holz- und Farbausführungen kombinieren. Die Beimöbel können zerlegt oder teilmontiert bestellt werden. Bei zusammengesetzten Möbeln (z. B. Qunito, Incentro, ...) muss der Deckel noch montiert werden. Bei Kommoden mit Türen ist jeweils ein Einlegeboden vorhanden, Türöffnung nach links oder rechts möglich. Zusätzliche Böden sind erhältlich.

Composez le meuble d'appoint de vos rêves selon vos goûts : Le caisson (ill. 02), disponible en 2 variantes de couleurs, peut être combiné avec les façades et couvercles supérieurs (ill. 03) en 8 finitions de bois et de coloris. Les meubles d'appoint peuvent être commandés en kits ou assemblés. Pour les meubles assemblés (p. ex. Qunito, Incentro, ...) le couvercle doit encore être fixé. Les commodes avec portes sont équipées d'une étagère, ouverture de la porte possible à gauche ou à droite. Si besoin, des étagères supplémentaires sont disponibles.

Put together the side furniture you want according to your own taste: The body (fig. 02), in two different colour versions, can be combined with the front and top covers (fig. 03) in eight wood and colour versions. The furniture can be ordered disassembled or assembled. For assembled furniture (e.g. Qunito, Incentro, ...) the top cover must still be fitted. Chests of drawers with doors have one shelf, door opening possible to the left or right. Additional shelves are available.



Kombinationsbeispiele und techn. Informationen
Exemples et informations
Examples and informations

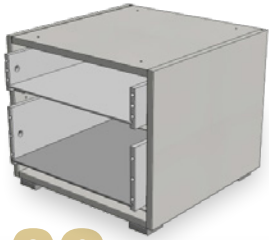

02

KORPUS

Caisson | Body



03

TOP/FRONT

Farben | Couleurs | Colours

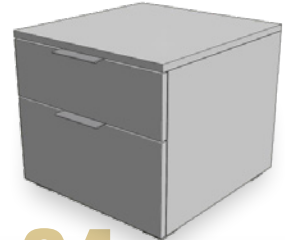

04

GRIFFE

Poignées | Handles



10 Weiss | Blanc | White



16 Anthracit | Anthracite



FÜSSE

Pieds | Feet

STANDARD



OPTION

Leg 8 cm



alu

Jone 10 cm



anthracit
used

Cila 10 cm



anthracit



10 Weiss | Blanc | White



16 Anthracit | Anthracite

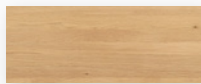

74 Eiche bright, geölt
Chêne bright, huilé
Oak bright, oiled

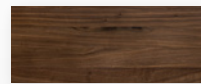

82 Nussbaum, geölt
Noyer, huilé
Walnut, oiled

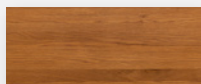

76 Eiche brandy, geölt
Chêne brandy, huilé
Oak brandy, oiled



87 Wildbuche natur, geölt
Hêtre nouveau naturel, huilé
Wildbeech natural, oiled



80 Kernbuche natur, geölt
Hêtre coeur rouge
naturel, huilé
Heart beech natural, oiled

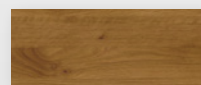

99 Wildeiche natur, geölt
Chêne nouveau naturel, huilé
Wildoak natural, oiled

STANDARD



Alu

Griff zu Folienfronten

Poignée pour façades en mélaminé
Handle for foil fronts

STANDARD



Holzgriff zu Holzfronten

Poignée en bois pour façades en bois
Wooden handle for wooden fronts

OPTION

Rivo



Used



Anthracit

Metallgriff zu Holzfronten

Poignée en métal pour façades en bois
Metal handle for wooden fronts



The mark of
responsible forestry
FSC® C123546

Look for FSC® certified products



				Dimension cm
Scola	Sekretär höhenverstellbar Schreibtischunterlage in Casual carbon 334	Secrétaire réglable en hauteur Sous-main de bureau en Casual carbon 334	Bureau adjustable in height Deskpad in Casual carbon 334	120/70/72-88
Carpi	Nachttisch höhenverstellbar 34–53 cm	Table de nuit réglable en hauteur 34–53 cm	Bedside table adjustable in height 34–53 cm	52/42/34-53



Alle Holzteile in Akazie Vintage brown, lackiert
 Toutes les parties en bois en acacia Vintage brown, laqué
 All wooden parts in acacia Vintage brown, lacquered

Weitere Beimöbel siehe Gesamtkatalog Register 2
 Autres accessoires voir catalogue général registre 2
 Further accessories see general catalogue index 2



	Dimension cm			
Bloc 16	Rahmen Breiten Längen	Cadre Largeurs Longueurs	Frame Widths Lengths	140, 160, 180, 200 200, 210, 220
Slid anthracit	Kufen Breiten Höhen	Patins Largeurs Hauteurs	Vats Widths Heights	140, 160, 180, 200 20, 25
Opera	Kopfteil, Fusio shell 750	Tête de lit, Fusio shell 750	Headboard, Fusio shell 750	140, 160, 180, 200

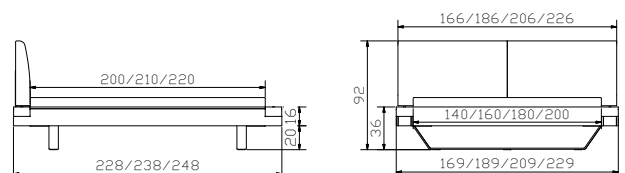



				Dimension cm
Bloc 16	Rahmen Breiten Längen	Cadre Largeurs Longueurs	Frame Widths Lengths	140, 160, 180, 200 200, 210, 220
Ivio	Füße Höhen	Pieds Hauteurs	Feet Heights	10, 20, 25
Varus	Kopfteil	Tête de lit	Headboard	90/100, 120, 140, 160, 180, 200
Ravo	Kissen Buffalo grey 721	Coussin Buffalo grey 721	Cushion Buffalo grey 721	90/100, 120, 140, 160, 180, 200

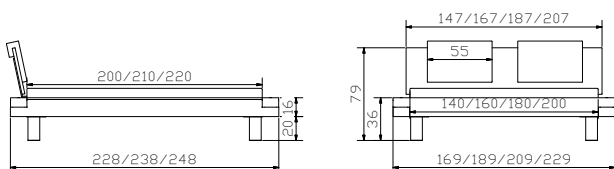

Alle Holzteile in Eiche uniq clear, geölt - Hergestellt aus recycletem Holz

Toutes les parties en bois en chêne uniq clear, huilé - Fabriqué en bois recyclé

All wooden parts in oak uniq clear, oiled - Made of recycled wood

Weitere Beimöbel siehe Gesamtkatalog Register 2 | Autres accessoires voir registre catalogue général 2 | Further accessories see general catalogue index 2



				Dimension cm
Dorma	Kopfteil, Buffalo grey 721	Tête de lit, Buffalo grey 721	Headboard, Buffalo grey 721	140, 160, 180, 200
Inca	Kopfteil	Tête de lit	Headboard	140/160, 180/200
Nakio	Kissen (2er Set) Buffalo grey 721	Coussins (set de 2) Buffalo grey 721	Cushions (set of 2) Buffalo grey 721	55/18/14
Lica	Nachttisch	Table de nuit	Bedside table	50/41/36



NO TIME TO WASTE

Mehr Informationen auf Seite 4
Plus d'informations à la page 4
More information on page 4

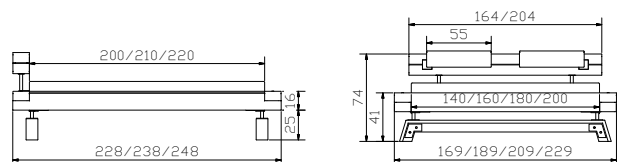



				Dimension cm
Calino	Kommode	Commode	Chest of drawers	105/46/71
Carpi	Nachttisch höhenverstellbar 34–53 cm	Table de nuit réglable en hauteur 34–53 cm	Bedside table adjustable in height 34–53 cm	52/42/34-53

Alle Holzteile in Akazie Vintage grey, lackiert | Toutes les parties en bois en acacia Vintage grey, laqué | All wooden parts in acacia Vintage grey, lacquered
Weitere Beimöbel siehe Gesamtkatalog Register 2 | Autres accessoires voir registre catalogue général 2 | Further accessories see general catalogue index 2



				Dimension cm
Bloc 16	Rahmen Breiten Längen	Cadre Largeurs Longueurs	Frame Widths Lengths	140, 160, 180, 200 200, 210, 220
Stabil	Kufen Breiten Höhe	Patins Largeurs Hauteur	Vats Widths Height	140, 160, 180, 200 25
Inca Nakio	Kopfteil Kissen (2er Set) Casual carbon 334	Tête de lit Coussins (set de 2) Casual carbon 334	Headboard Cushions (set of 2) Casual carbon 334	140/160, 180/200 55/18/14

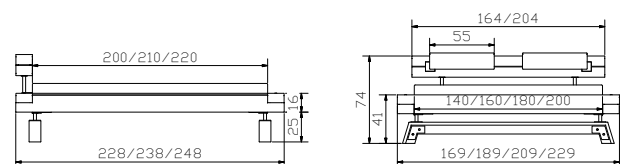



				Dimension cm
Calino	Kommode	Commode	Chest of drawers	105/46/71
Jesa	Nachttisch	Table de nuit	Bedside table	50/41/36

Alle Holzteile in Akazie Vintage brown, lackiert | Toutes les parties en bois en acacia Vintage brown, laqué | All wooden parts in acacia Vintage brown, lacquered
Weitere Beimöbel siehe Gesamtkatalog Register 2 | Autres accessoires voir registre catalogue général 2 | Further accessories see general catalogue index 2



	Dimension cm			
Loft 18	Rahmen Breiten Längen Winkel (8er-Set)	Cadre Largeurs Longueurs Équerres (set de 8)	Frame Widths Lengths Brackets (set of 8)	90, 100, 120, 140, 160, 180, 200 200, 210, 220
Case 8 used				
Gola	Füße Höhen	Pieds Hauteurs	Feet Heights	20, 25
Varus	Kopfteil	Tête de lit	Headboard	140, 160, 180, 200
Ravo	Kissen, Casual carbon 334	Coussin, Casual carbon 334	Cushion, Casual carbon 334	140, 160, 180, 200

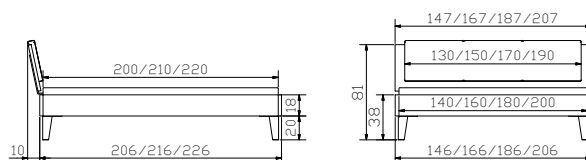



				Dimension cm
Topa bronze	Bank inkl.Kissen Cyclo cream 730	Banquette, Coussin incl. Cyclo cream 730	Bench, Cushion incl. Cyclo cream 730	144/44/38
Scola	Sekretär, höhenverstellbar Schreibtischunterlage in Casual carbon 334	Secrétaire, réglable en hauteur Équerres (set de 4) Sous-main de bureau en Casual carbon 334	Bureau, adjustable in height Brackets (set of 8) Deskpad in Casual carbon 334	120/70/72-88
Case used	Winkel (4er-Set)			
Carpi	Nachttisch höhenverstellbar 34–53 cm	Table de nuit réglable en hauteur 34–53 cm	Bedside table adjustable in height 34–53 cm	52/42/34-53
Smart black	Leselampe (2er Set) 12V DC, 30 LED warm	Lampe de lecture (Set de 2) 12V DC, 30 LED warm	Reading lamp (Set of 2) 12V DC, 30 LED warm	

Alle Holzteile in Akazie Vintage grey, lackiert | Toutes les parties en bois en acacia Vintage grey, laqué | All wooden parts in acacia Vintage grey, lacquered
Leselampen und weitere Beimöbel siehe Gesamtkatalog Register 2 | Lampes de lecture et autres accessoires voir catalogue général registre 2 | Reading lamps and further accessories see general catalogue index 2



				Dimension cm
Loft 18	Rahmen Breiten Längen	Cadre Largeurs Longueurs	Frame Widths Lengths	90, 100, 120, 140, 160, 180, 200 200, 210, 220
Fasio bronze	Füsse Höhe	Pieds Hauteur	Feet Height	20
Boga	Kopfteil, Cyclo cream 730 siehe Gesamtkatalog Register 1	Tête de lit, Cyclo cream 730 voir catalogue général registre 1	Headboard, Cyclo cream 730 see general catalogue index 1	90, 100, 120, 140, 160, 180, 200

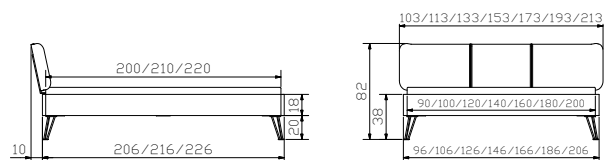



				Dimension cm
Scola	Sekretär, höhenverstellbar Schreibtischunterlage in Casual carbon 334	Secrétaire, réglable en hauteur Équerres (set de 4) Sous-main de bureau en	Bureau, adjustable in height Brackets (set of 8) Deskpad in Casual carbon 334	120/70/72-88
Calino	Kommode	Commode	Chest of drawers	105/46/71
Lica	Nachttisch	Table de nuit	Bedside table	50/41/36
Coban	Bank	Banquette	Bench	144/44/36
Curty	Baldachin-Vorhang (3er Set) Baumwolle weiss	Rideau de baldaquin (set de 3) Coton blanc	Curtain of canopy (set of 3) Cotton white	272/185 (3x)



Curty

Alle Holzteile in Akazie Vintage brown, lackiert

Toutes les parties en bois en acacia Vintage brown, laqué
All wooden parts in acacia Vintage brown, lacquered

Weitere Beimöbel siehe Gesamtkatalog Register 2

Autres accessoires voir catalogue général registre 2
Further accessories see general catalogue index 2



				Dimension cm
Loft 18	Rahmen Breiten Längen	Cadre Largeurs Longueurs	Frame Widths Lengths	90, 100, 120, 140, 160, 180, 200 200, 210, 220
Cielo anthracit	Baldachin Breiten Längen Höhe, Boden bis Unterkante Bettrahmen	Baldaquin Largeurs Longueurs Hauteur, Du sol au bord Inférieur du cadre du lit	Canopy Widths Lengths Height, Floor to lower Edge of bed frame	120, 140, 160, 180, 200 200, 210, 220 20
Obag	Kopfteil, Casual carbon 334 siehe Gesamtkatalog Register 1	Tête de lit, Casual carbon 334 voir catalogue général registre 1	Headboard, Casual carbon 334 see general catalogue index 1	140, 160, 180, 200

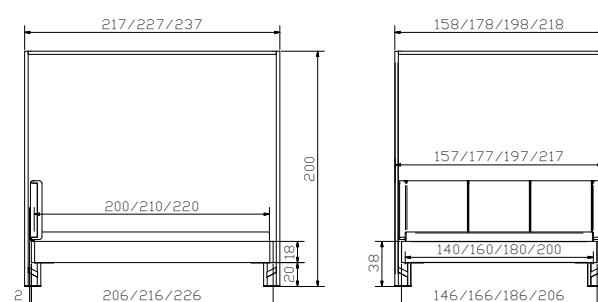



				Dimension cm
Malta	Kopfteil	Tête de lit	Headboard	120, 140, 160, 180, 200
	Alpina smoke 394	Alpina smoke 394	Alpina smoke 394	
	Alpina lightgrey 390	Alpina lightgrey 390	Alpina lightgrey 390	
	siehe Gesamtkatalog Register 1	voir catalogue général registre 1	see general catalogue index 1	
Calino	Kommode	Commode	Chest of drawers	105/46/71

Alle Holzteile in Eiche uniq clear, geölt - Hergestellt aus recycletem Holz | Toutes les parties en chêne uniq clear, huilé - Huilé fabriqué en bois recyclé |
 All wooden parts in oak uniq clear, oiled - Made of recycled wood

Weitere Beimöbel siehe Gesamtkatalog Register 2 | Autres accessoires voir registre catalogue général 2 | Further accessories see general catalogue index 2



				Dimension cm
Loft 18	Rahmen Breiten Längen	Cadre Largeurs Longueurs	Frame Widths Lengths	90, 100, 120, 140, 160, 180, 200 200, 210, 220
Case 8 used	Winkel (8er-Set)	équerres (Set de 8)	Brackets (Set of 8)	
Ivio	Füsse Höhen	Pieds Hauteurs	Feet Heights	10, 20, 25
Malta	Kopfteil, Capo 763 Linen siehe Gesamtkatalog Register 1	Tête de lit, Capo 763 Linen voir catalogue général registre 1	Headboard, Capo 763 Linen see general catalogue index 1	120, 140, 160, 180, 200
Roll-Box	Bettkasten, weiss Höhen	Tiroir de lit, blanc Hauteurs	Bed drawer, white Heights	137/67 19, 24
Jago	Nachttisch	Table de nuit	Bedside table	50/41/16



NO TIME TO WASTE

Mehr Informationen auf Seite 4
Plus d'informations à la page 4
More information on page 4

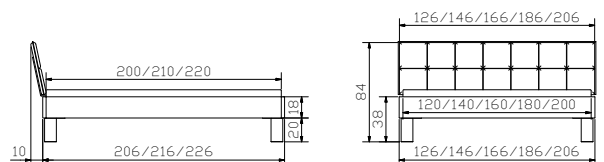



				Dimension cm
Dowe	Nachttisch	Table de nuit	Bedside table	45/49/55
Lovie-Box	1 Bettkasten	1 Tiroir de lit	1 Bed drawer	140
	Breite	Largeur	Width	140
	2 Bettkästen	2 Tiroirs de lit	2 Bed drawers	140, 160, 180, 200
	Breiten	Largeurs	Widths	140, 160, 180, 200
	Höhe	Hauteur	Height	25

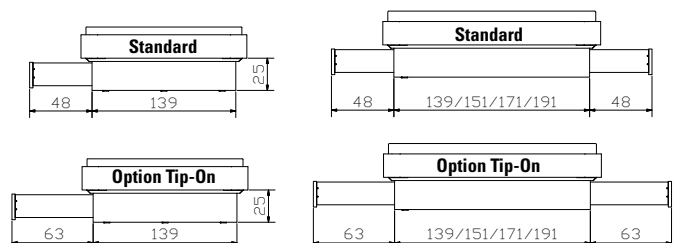

Cone 23



				Dimension cm
Cone 23	Rahmen Breiten Längen	Cadre Largeurs Longueurs	Frame Widths Lengths	140, 160, 180, 200 200, 210, 220
Gola	Füße Höhen	Pieds Hauteurs	Feet Heights	20, 25
Varus	Kopfteil	Tête de lit	Headboard	140, 160, 180, 200



NO TIME TO WASTE

Mehr Informationen auf Seite 4
Plus d'informations à la page 4
More information on page 4

Alle Holzteile in Eiche uni clear, geölt - Hergestellt aus recycletem Holz

Toutes les parties en bois en chêne uni clear, huilé - Fabriqué en bois recyclé
All wooden parts in oak uni clear, oiled - Made of recycled wood

Weitere Beimöbel siehe Gesamtkatalog Register 2 | Autres accessoires voir registre catalogue général 2 | Further accessories see general catalogue index 2

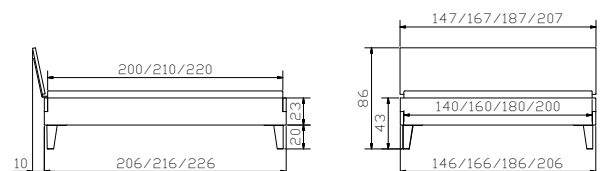



Jago

Nachttisch

Table de nuit

Bedside table

Dimension cm

50/41/16



Alle Holzteile in Eiche uniq clear, geölt - Hergestellt aus recycletem Holz

Toutes les parties en bois en chêne uniq clear, huilé - Fabriqué en bois recyclé
All wooden parts in oak uniq clear, oiled - Made of recycled wood

Weitere Beimöbel siehe Gesamtkatalog Register 2 | Autres accessoires voir registre catalogue général 2 | Further accessories see general catalogue index 2



				Dimension cm
Cone 23	Rahmen Breiten Längen	Cadre Largeurs Longueurs	Frame Widths Lengths	140, 160, 180, 200 200, 210, 220
Jeno used	Füße Höhen	Pieds Hauteurs	Feet Heights	10, 20, 25
Cussina	Kopfteil, Fusio shell 750	Tête de lit, Fusio shell 750	Headboard, Fusio shell 750	140, 160, 180, 200



NO TIME TO WASTE

Mehr Informationen auf Seite 4
Plus d'informations à la page 4
More information on page 4

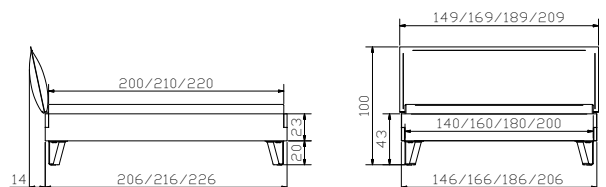



				Dimension cm
Coban	Bank	Banquette	Bench	144/44/36
Vano	Kissen, Vintage marone 521	Coussin, Vintage marone 521	Cushion, Vintage marone 521	136/34/4
Quatro	Kommode	Commode	Chest of drawers	45/49/85
Onia	Nachttisch	Table de nuit	Bedside table	45/49/40

Alle Holzteile in Akazie Vintage brown, lackiert | Toutes les parties en bois en acacia Vintage brown, laqué | All wooden parts in acacia Vintage brown, lacquered
Weitere Beimöbel siehe Gesamtkatalog Register 2 | Autres accessoires voir registre catalogue général 2 | Further accessories see general catalogue index 2



				Dimension cm
Cone 23	Rahmen Breiten Längen	Cadre Largeurs Longueurs	Frame Widths Lengths	140, 160, 180, 200 200 (210), 210 (220)
Tondo anthracit	Füße Höhe	Pieds Hauteur	Feet Height	20
Cena	Kopfteil, Vintage marone 521 hat Einfluss auf Bettlänge siehe Gesamtkatalog Register 1 Seite 4	Tête de lit, Vintage marone 521 a un impact sur la longueur du lit voir catalogue général registre 1 page 4	Headboard, Vintage marone 521 affects the length of bed see general catalogue index 1 page 4	140, 160, 180, 200

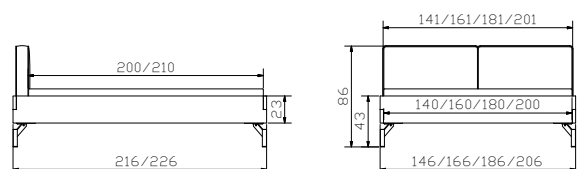



MOVIE-/TOP LINE



FACTORY LINE



WOOD LINE



LOUNGE



FINE LINE



NATURO LINE



OAK LINE



OAK WILD



DREAM LINE



**EDITION
BOXSPRING**



**FUNCTION/COMFORT
KIDS & GUESTS**



**LATTENROSTE &
MATRATZEN**



Gesamtkatalog
Catalogue général
General catalogue



Schlafwohl

Markenmatratzen & Bettsysteme